

FUZETEC

MOV Catalog

Metal Oxide Varistor
OverVoltage
Circuit
Protection

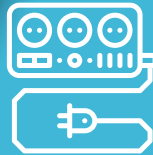

FUZETEC

Circuit Protection Solutions for Today & Tomorrow's Industries

C ontents

I	Fundamental
P.2-P.3	Company Profile
II	Transient
P.4-P.5	MOV Characteristics
III	Standard D Series
P.6-P.11	Product Description FMOV05-D FMOV07-D FMOV10-D FMOV14-D FMOV20-D
p.12-P.18	Transient V-I Characteristic Curves
p.19-P.22	Impulse Life Time Rating Curves
P.23	Power Derating Curve
P.24	Product Dimensions
P.25	Part Numbering & Marking System/Order Notes
P.26	Tape & Reel Specifications
P.27	Packaging Information
IV	Medium Surge V Series
P.28 -P.33	Product Description FMOV05-V FMOV07-V FMOV10-V FMOV14-V FMOV20-V
P.34-P.38	Transient V-I Characteristic Curves
P.39-P.40	Impulse Life Time Rating Curves
P.41	Power Derating Curve
P.42	Product Dimensions
P.43	Part Numbering & Marking System/Order Notes
P.44	Tape & Reel Specifications
P.45	Packaging Information
V	High energy P Series
P.46-P.49	Product Description FMOV10-P FMOV14-P FMOV20-P
P.50-P.52	Transient V-I Characteristic Curves
P.53 -P.54	Impulse Life Time Rating Curves
P.55	Power Derating Curve
P.56	Product Dimensions
P.57	Part Numbering & Marking System/Order Notes
P.58	Tape & Reel Specifications
P.59	Packaging Information
VI	Appendix
P.60 -p.61	Product Reliability
P.62	Material Information & Soldering Recommendation
P.63	Cross Reference



FUZETEC

“

Transient Events

Occurs hundreds of times per day

60~80% of surges are created within facility

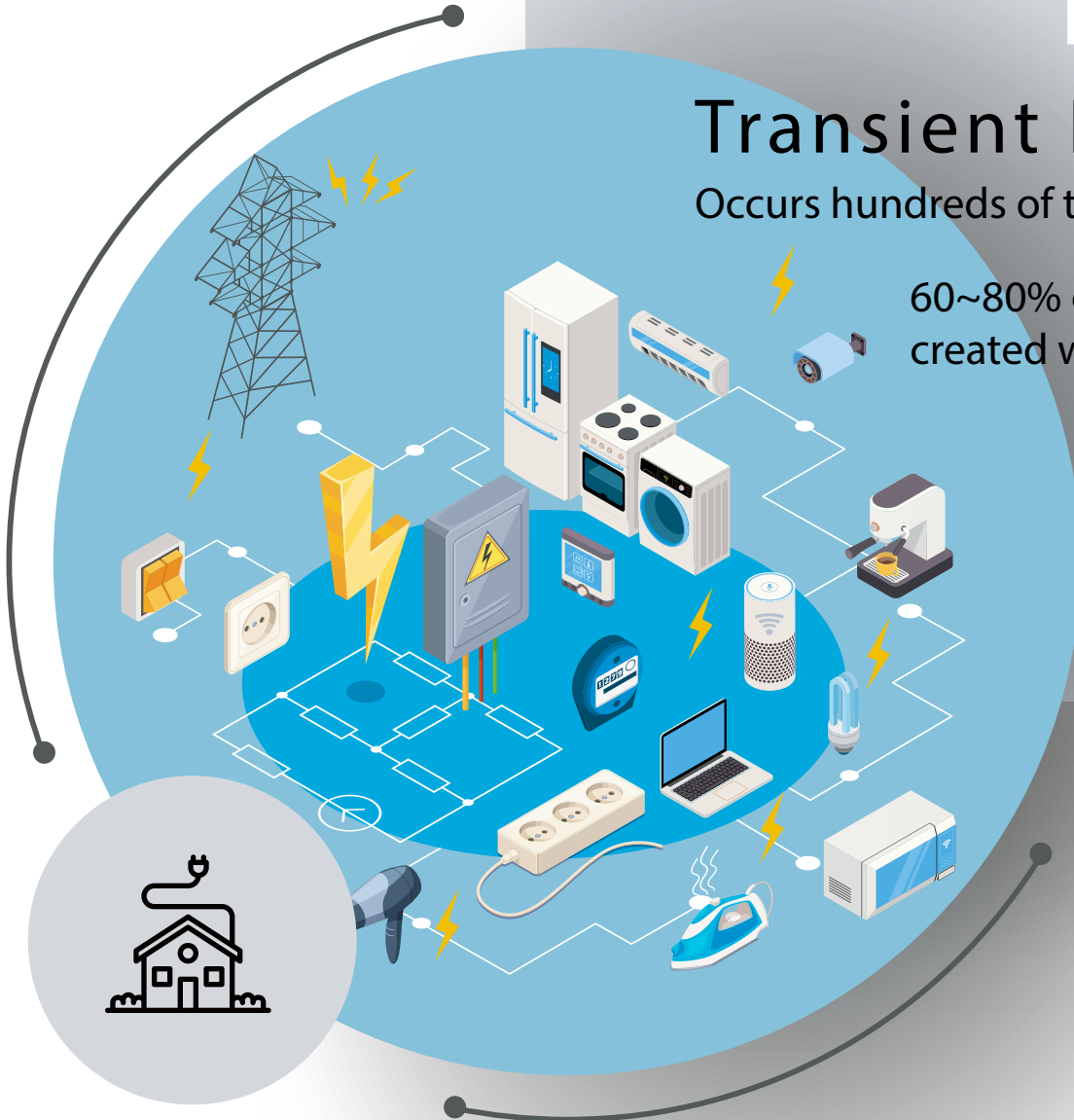

Over voltage Circuit Protection

Over voltage circuit Protection on AC and DC power lines is necessary for just about any device. Varying levels of exposure to lightning and switching transients, poor line voltage regulation rural and developing areas and inconsistency among different grids around the globe means that there is no recognized single universal solution.



Threats from Transient Surge

External Sources

The most recognizable source of surges generated outside the facility is lightning. Lightning surge is energy induced into the power grid by lightning strike. It can be magnetic coupling or direct hit. The event causes momentary high voltage on the power lines feeding a home or business.

Other external sources of surges include utility-initiated grid and capacitor bank switching. Power quality disturbances can be delivered during the normal operation of the electric power system

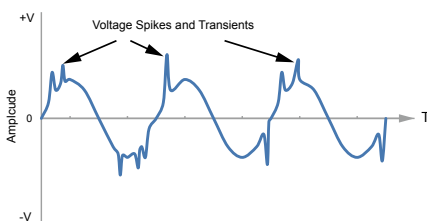

Transient Surges

Transient surges are brief overvoltage spikes or disturbances on a power waveform that can damage, degrade, or destroy electronic equipment. Transient surges originate from a variety of electrical circuits and sources regardless of whether they operate from an AC or DC supply as they are often generated within the circuit itself or transmitted into the circuit from external sources. Transients within a circuit can increase the voltage to several thousand volts with a duration of less than a half-cycle of the normal voltage waveform, and it is these voltage spikes which must be prevented from appearing across delicate electronic circuits and components.

MOVs are designed to protect sensitive circuits against external transients (lightning) and internal transients (inductive load switching, relay switching and capacitor discharges). And other high level transients found in industrial, AC line application or lower level transients found in automotive DC line applications

Internal Sources:

Switching of Electrical Loads

- Starting and stopping of loads
- Switching of capacitor banks & loads
- Discharge of inductive devices (motors, transformers, etc.)
- Contactor, relay and breaker operations

Magnetic and Inductive coupling

- Elevators
- HVAC with Variable frequency driver
- Computer/ Copy Machines

Static electricity

- Electrostatic discharge (ESD) phenomena

Fuzetec Technology

Overvoltage Circuit Protection

Fuzetec has been a trusted name in circuit protection industry for 20 years. We provide highest quality PPTC resettable overcurrent protection solutions for industries which require high reliability, high design flexibility and outstanding product performance, such as Automotive and Industrial markets.

Circuit protection is never complete without overvoltage protection, as an established provider of overcurrent protection, we realized the demand for better integration between the two circuit protection design solution.

MOV Structure

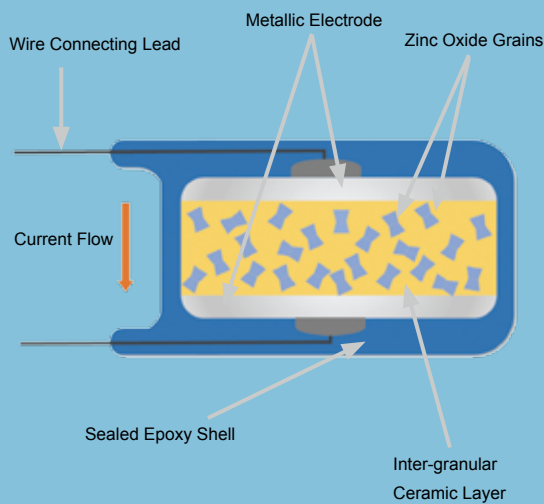

Fig.1

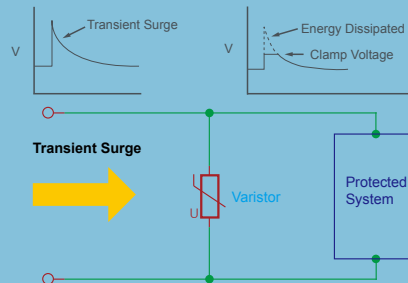

Fig.2

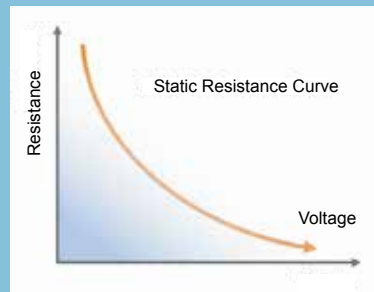

Fig.3

MOV Characteristics

The Metal Oxide Varistor or MOV, is a voltage dependent resistor in which the resistance material is a metallic oxide, primarily zinc oxide (ZnO) as a ceramic base, plus other filler materials for the formation of junctions between the zinc oxide grains. Conductive ZnO grains separated by grain boundaries providing P-N junction semiconductor characteristics.

Under normal operation the varistor has a very high resistance, operating in a similar way to the zener diode by allowing lower threshold voltages to pass unaffected.

However, when the voltage across the varistor (either polarity) exceeds the varistor's rated value, its effective resistance decreases strongly with an increasing voltage as shown.

The varistor changes its resistance value automatically with the change in voltage across it making it a voltage-dependent, non-linear resistor. The potentially destructive energy of the incoming transient pulse is absorbed by the Varistor and dissipates it as heat, thereby protecting vulnerable circuit components and preventing system damage.

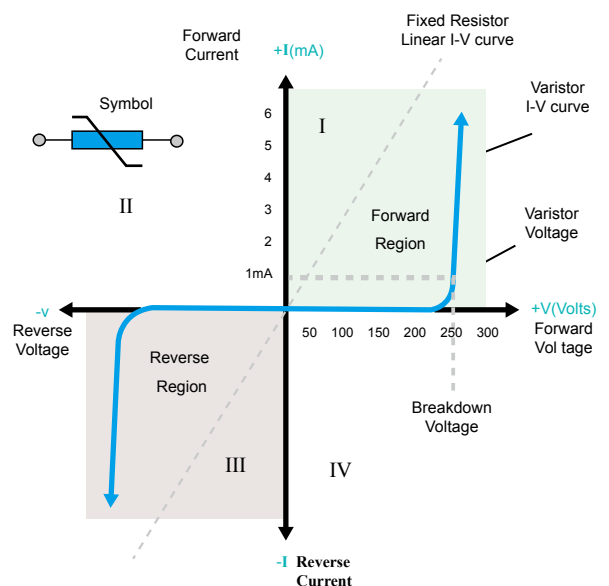
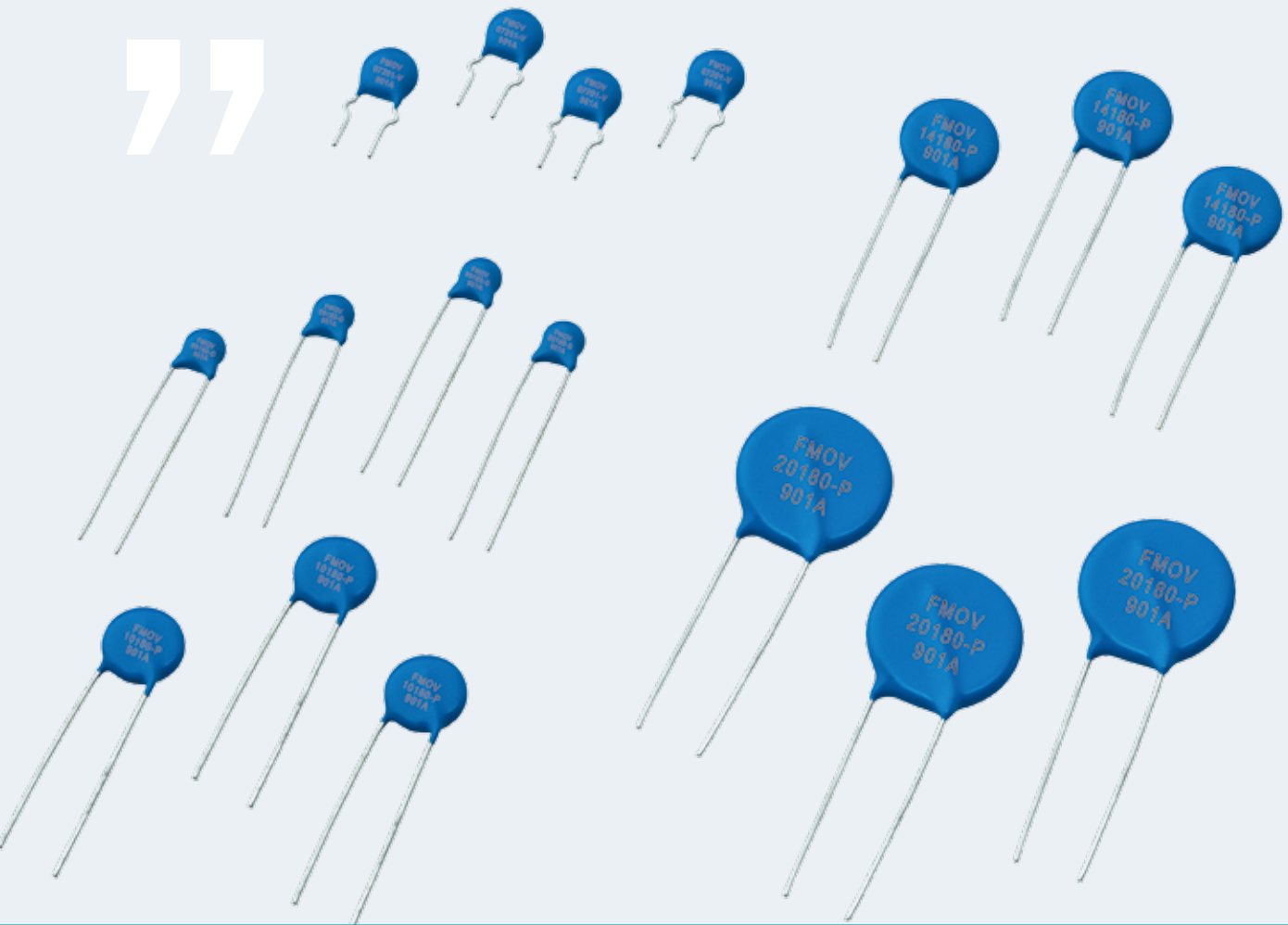

Fig.4



We can see from Fig. 4, that the varistor has symmetrical bi-directional characteristics that is the varistor operates in both directions (quadrant I and III) of a sinusoidal waveform behaving in a similar way to two zener diodes connected back-to-back. When not conducting, the I-V curve shows a linear relationship as the current flowing through the varistor remains constant and low at only a few micro-amperes of “leakage” current. This is due to its high resistance acting as an open circuit and remains constant until the voltage across the varistor (either polarity) reaches a particular “rated voltage”.

This rated or “varistor voltage” is the voltage across the varistor measured with the specified DC current of 1mA. That is, the DC voltage level applied across its terminals that allows a current of 1mA to flow through the varistors. At this voltage level, the varistor begins to change from its insulating state into its conducting state.

When the transient voltage across the varistor is equal to or greater than the rated value, the resistance of the device suddenly becomes very small turning the varistor into a conductor due to the avalanche effect of its semiconductor material. The small leakage current flowing through the varistor rapidly rises but the voltage across it is limited to a level just above the varistor voltage.

In other words, the varistor self-regulates the transient voltage across it by allowing more current to flow through it and because of its steep non-linear I-V curve it can pass widely varying currents over a narrow voltage range clipping-off any voltage spikes.

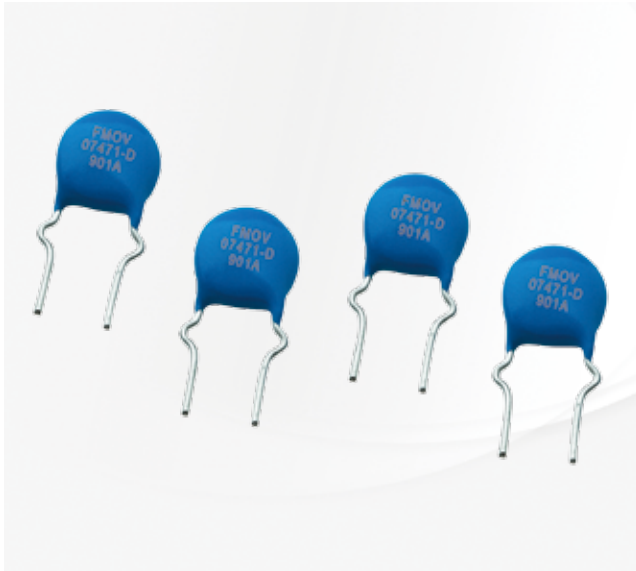

Description :

Fuzetec D Series Metal Oxide Varistors (MOV) are the standard radial leaded MOV products designed for continuous AC power applications. Available in wide range of voltage & current ratings, the standard D series is design for circuit systems requiring low to medium level of surge immunity. MOV products have specific nonlinear and symmetrical V-I characteristics curve and unparalleled large peak current capability are used for absorption of transient voltage, suppression of pulse noise and circuit voltage stabilization.

Agency Approvals

Agency	Agency Approvals	File Number
C _{UL} US	UL 1449 4th & cUL	VZCA2.E515006 VZCA8.E515006



SVHC Compliant



Features :

- RoHS compliant
- Halogen-free series are available
- Body size: $\Phi 05 \sim \Phi 20\text{mm}$



Applications :

- Power supply
- Home appliance
- Industrial equipment
- Telecommunication system
- Smart meter
- Lighting products
- Photovoltaic industry

Absolute Maximum Ratings

	D Series	Units
Steady State :		
AC Voltage Range (V_{AC})	11 to 1000	V
DC Voltage Range (V_{DC})	14 to 1465	V
Transients :		
Peak Current for 8/20 μ S Current Wave	100 to 6500	A
Energy Range For 10/1000 μ S Current Wave	0.4 to 620	J
Operation Ambient Temperature Range	-40 to +105	$^{\circ}\text{C}$
Storage Temperature Range	-40 to +125	$^{\circ}\text{C}$
Varistor Voltage Range $V_n(V_{DC})$	18 to 1800	V
Insulation Resistance	>1000	M Ω
Typical Response Time	<25	ns

FMOV05-D Series

Device Ratings and Characteristics												
Part Number	Maximum Continuous Voltage		Varistor Voltage (@1mA)			Maximum Clamping Voltage @Test Current (@8/20µs)		Maximum Energy (@10/1000µs)	Maximum Peak Current (@8/20µs)	Rated Power	Typical Capacitance (@1KHz)	Agency Approvals
	ACrms(V)	DC(V)	Vn(V _{DC})	Min.	Max.	Vc(V)	I _p (A)	(J)	(A)	(W)	(pF)	
FMOV05180-D	11	14	18	16	20	40	1	0.4	100	0.01	1600	
FMOV05220-D	14	18	22	20	24	48	1	0.5	100	0.01	1500	
FMOV05270-D	17	22	27	24	30	60	1	0.6	100	0.01	1450	
FMOV05330-D	20	26	33	30	36	73	1	0.8	100	0.01	1400	
FMOV05390-D	25	31	39	35	43	86	1	0.9	100	0.01	700	
FMOV05470-D	30	38	47	42	52	104	1	1.1	100	0.01	650	
FMOV05560-D	35	45	56	50	62	123	1	1.3	100	0.01	600	
FMOV05680-D	40	56	68	61	75	150	1	1.6	100	0.01	580	
FMOV05820-D	50	65	82	74	90	145	5	2.5	400	0.10	310	
FMOV05101-D	60	85	100	90	110	175	5	3.0	400	0.10	290	
FMOV05121-D	75	100	120	108	132	210	5	4.0	400	0.10	270	
FMOV05151-D	95	125	150	135	165	260	5	4.8	400	0.10	240	
FMOV05181-D	115	150	180	162	198	315	5	5.9	400	0.10	140	
FMOV05201-D	130	170	200	180	220	355	5	6.5	400	0.10	120	
FMOV05221-D	140	180	220	198	242	380	5	7.0	400	0.10	110	
FMOV05241-D	150	200	240	216	264	415	5	8.0	400	0.10	110	
FMOV05271-D	175	225	270	243	297	475	5	8.5	400	0.10	100	
FMOV05301-D	195	250	300	270	330	505	5	9.0	400	0.10	100	
FMOV05331-D	215	275	330	297	363	585	5	10.0	400	0.10	90	
FMOV05361-D	230	300	360	324	396	620	5	10.0	400	0.10	80	
FMOV05391-D	250	320	390	351	429	675	5	12.0	400	0.10	80	
FMOV05431-D	275	350	430	387	473	745	5	13.0	400	0.10	70	
FMOV05471-D	300	385	470	423	517	810	5	15.0	400	0.10	70	
FMOV05511-D	320	410	510	459	561	878	5	16.0	400	0.10	65	
FMOV05561-D	350	460	560	504	616	940	5	18.0	400	0.10	65	
FMOV05621-D	395	510	620	558	682	1050	5	18.0	400	0.10	65	
FMOV05681-D	420	560	680	612	748	1120	5	18.0	400	0.10	60	
FMOV05751-D	460	615	750	675	825	1240	5	18.0	400	0.10	60	

FMOV07-D Series

Device Ratings and Characteristics												
Part Number	Maximum Continuous Voltage		Varistor Voltage (@1mA)			Maximum Clamping Voltage @Test Current (@8/20µs)		Maximum Energy (@10/1000µs)	Maximum Peak Current (@8/20µs)	Rated Power	Typical Capacitance (@1KHz)	Agency Approvals
	ACrms(V)	DC(V)	Vn(Vbc)	Min.	Max.	Vc(V)	Ip(A)	(J)	(A)	(W)	(pF)	
FMOV07180-D	11	14	18	16	20	36	2.5	0.9	250	0.02	3800	
FMOV07220-D	14	18	22	20	24	43	2.5	1.1	250	0.02	3600	
FMOV07270-D	17	22	27	24	30	53	2.5	1.4	250	0.02	3400	
FMOV07330-D	20	26	33	30	36	65	2.5	1.7	250	0.02	2900	
FMOV07390-D	25	31	39	35	43	77	2.5	2.1	250	0.02	1600	
FMOV07470-D	30	38	47	42	52	93	2.5	2.5	250	0.02	1550	
FMOV07560-D	35	45	56	50	62	110	2.5	3.1	250	0.02	1500	
FMOV07680-D	40	56	68	61	75	135	2.5	3.6	250	0.02	1200	
FMOV07820-D	50	65	82	74	90	135	10	5.5	1200	0.25	860	
FMOV07101-D	60	85	100	90	110	165	10	6.5	1200	0.25	750	
FMOV07121-D	75	100	120	108	132	200	10	7.8	1200	0.25	530	
FMOV07151-D	95	125	150	135	165	250	10	9.7	1200	0.25	410	
FMOV07181-D	115	150	180	162	198	300	10	11.7	1200	0.25	300	
FMOV07201-D	130	170	200	180	220	340	10	13	1200	0.25	250	
FMOV07221-D	140	180	220	198	242	360	10	14	1200	0.25	250	
FMOV07241-D	150	200	240	216	264	395	10	15	1200	0.25	240	
FMOV07271-D	175	225	270	243	297	455	10	18	1200	0.25	220	
FMOV07301-D	195	250	300	270	330	500	10	21	1200	0.25	190	
FMOV07331-D	215	275	330	297	363	550	10	25	1200	0.25	180	
FMOV07361-D	230	300	360	324	396	595	10	25	1200	0.25	170	
FMOV07391-D	250	320	390	351	429	650	10	25	1200	0.25	160	
FMOV07431-D	275	350	430	387	473	710	10	28	1200	0.25	150	
FMOV07471-D	300	385	470	423	517	775	10	30	1200	0.25	130	
FMOV07511-D	320	410	510	459	561	845	10	33	1200	0.25	120	
FMOV07561-D	350	460	560	504	616	915	10	33	1200	0.25	120	
FMOV07621-D	395	510	620	558	682	1020	10	35	1200	0.25	120	
FMOV07681-D	420	560	680	612	748	1120	10	35	1200	0.25	110	
FMOV07751-D	465	615	750	675	825	1235	10	38	1200	0.25	100	
FMOV07781-D	485	640	780	702	858	1290	10	40	1200	0.25	90	
FMOV07821-D	510	670	820	738	902	1355	10	42	1200	0.25	90	

FMOV10-D Series

Device Ratings and Characteristics												
Part Number	Maximum Continuous Voltage		Varistor Voltage (@1mA)			Maximum Clamping Voltage @Test Current (@8/20µs)		Maximum Energy (@10/1000µs)	Maximum Peak Current (@8/20µs)	Rated Power	Typical Capacitance (@1KHz)	Agency Approvals
	ACrms(V)	DC(V)	Vn(V _{DC})	Min.	Max.	Vc(V)	I _p (A)	(J)	(A)	(W)	(pF)	
FMOV10180-D	11	14	18	16	20	36	5	2.1	500	0.05	16000	C _{RU} US
FMOV10220-D	14	18	22	20	24	43	5	2.5	500	0.05	11000	
FMOV10270-D	17	22	27	24	30	53	5	3.0	500	0.05	8000	
FMOV10330-D	20	26	33	30	36	65	5	4.0	500	0.05	6300	
FMOV10390-D	25	31	39	35	43	77	5	4.6	500	0.05	5200	
FMOV10470-D	30	38	47	42	52	93	5	5.5	500	0.05	4600	
FMOV10560-D	35	45	56	50	62	110	5	7.0	500	0.05	3750	
FMOV10680-D	40	56	68	61	75	135	5	8.2	500	0.05	2800	
FMOV10820-D	50	65	82	74	90	135	25	12	2500	0.4	1920	
FMOV10101-D	60	85	100	90	110	165	25	15	2500	0.4	1800	
FMOV10121-D	75	100	120	108	132	200	25	18	2500	0.4	1500	
FMOV10151-D	95	125	150	135	165	250	25	22	2500	0.4	1200	
FMOV10181-D	115	150	180	162	198	300	25	27	2500	0.4	620	
FMOV10201-D	130	170	200	180	220	340	25	30	2500	0.4	570	
FMOV10221-D	140	180	220	198	242	360	25	32	2500	0.4	560	
FMOV10241-D	150	200	240	216	264	395	25	35	2500	0.4	550	
FMOV10271-D	175	225	270	243	297	455	25	40	2500	0.4	530	
FMOV10301-D	195	250	300	270	330	500	25	42	2500	0.4	500	
FMOV10331-D	215	275	330	297	363	550	25	47	2500	0.4	450	
FMOV10361-D	230	300	360	324	396	595	25	47	2500	0.4	450	
FMOV10391-D	250	320	390	351	429	650	25	60	2500	0.4	430	
FMOV10431-D	275	350	430	387	473	710	25	65	2500	0.4	400	
FMOV10471-D	300	385	470	423	517	775	25	70	2500	0.4	300	
FMOV10511-D	320	410	510	459	561	845	25	70	2500	0.4	260	
FMOV10561-D	350	460	560	504	616	915	25	70	2500	0.4	200	
FMOV10621-D	395	510	620	558	682	1020	25	70	2500	0.4	170	
FMOV10681-D	420	560	680	612	748	1120	25	70	2500	0.4	160	
FMOV10751-D	465	615	750	675	825	1235	25	75	2500	0.4	150	
FMOV10781-D	485	640	780	702	858	1290	25	80	2500	0.4	150	
FMOV10821-D	510	670	820	738	902	1355	25	85	2500	0.4	150	
FMOV10911-D	550	745	910	819	1001	1500	25	93	2500	0.4	140	
FMOV10102-D	625	825	1000	900	1100	1650	25	102	2500	0.4	140	
FMOV10112-D	680	895	1100	990	1210	1815	25	115	2500	0.4	130	
FMOV10182-D	1000	1465	1800	1620	1980	2950	25	185	2500	0.4	75	

FMOV14-D Series

Device Ratings and Characteristics												
Part Number	Maximum Continuous Voltage		Varistor Voltage (@1mA)			Maximum Clamping Voltage @Test Current (@8/20µs)		Maximum Energy (@10/1000µs)	Maximum Peak Current (@8/20µs)	Rated Power	Typical Capacitance (@1KHz)	Agency Approvals
	ACrms(V)	DC(V)	Vn(Vbc)	Min.	Max.	Vc(V)	Ip(A)	(J)	(A)	(W)	(pF)	
FMOV14180-D	11	14	18	16	20	36	10	4	1000	0.1	25000	
FMOV14220-D	14	18	22	20	24	43	10	5	1000	0.1	20000	
FMOV14270-D	17	22	27	24	30	53	10	6	1000	0.1	16000	
FMOV14330-D	20	26	33	30	36	65	10	7.5	1000	0.1	12200	
FMOV14390-D	25	31	39	35	43	77	10	8.6	1000	0.1	7000	
FMOV14470-D	30	38	47	42	52	93	10	10	1000	0.1	6750	
FMOV14560-D	35	45	56	50	62	110	10	11	1000	0.1	6500	
FMOV14680-D	40	56	68	61	75	135	10	14	1000	0.1	5500	
FMOV14820-D	50	65	82	74	90	135	50	22	4500	0.6	4300	
FMOV14101-D	60	85	100	90	110	165	50	28	4500	0.6	3500	
FMOV14121-D	75	100	120	108	132	200	50	32	4500	0.6	2500	
FMOV14151-D	95	125	150	135	165	250	50	40	4500	0.6	2100	
FMOV14181-D	115	150	180	162	198	300	50	52	4500	0.6	1250	
FMOV14201-D	130	170	200	180	220	340	50	57	4500	0.6	1150	
FMOV14221-D	140	180	220	198	242	360	50	60	4500	0.6	1100	
FMOV14241-D	150	200	240	216	264	395	50	63	4500	0.6	1050	
FMOV14271-D	175	225	270	243	297	455	50	70	4500	0.6	1000	
FMOV14301-D	195	250	300	270	330	500	50	78	4500	0.6	900	
FMOV14331-D	215	275	330	297	363	550	50	93	4500	0.6	850	
FMOV14361-D	230	300	360	324	396	595	50	93	4500	0.6	800	
FMOV14391-D	250	320	390	351	429	650	50	100	4500	0.6	800	
FMOV14431-D	275	350	430	387	473	710	50	115	4500	0.6	650	
FMOV14471-D	300	385	470	423	517	775	50	125	4500	0.6	550	
FMOV14511-D	320	410	510	459	561	845	50	125	4500	0.6	450	
FMOV14561-D	350	460	560	504	616	915	50	125	4500	0.6	400	
FMOV14621-D	395	510	620	558	682	1020	50	125	4500	0.6	350	
FMOV14681-D	420	560	680	612	748	1120	50	130	4500	0.6	350	
FMOV14751-D	465	615	750	675	825	1235	50	143	4500	0.6	330	
FMOV14781-D	485	640	780	702	858	1290	50	148	4500	0.6	330	
FMOV14821-D	510	670	820	738	902	1355	50	157	4500	0.6	330	
FMOV14911-D	550	745	910	819	1001	1500	50	175	4500	0.6	300	
FMOV14102-D	625	825	1000	900	1100	1650	50	190	4500	0.6	300	
FMOV14112-D	680	895	1100	990	1210	1815	50	213	4500	0.6	200	
FMOV14182-D	1000	1465	1800	1620	1980	2950	50	354	4500	0.6	150	

FMOV20-D Series

Device Ratings and Characteristics												
Part Number	Maximum Continuous Voltage		Varistor Voltage (@1mA)			Maximum Clamping Voltage @Test Current (@8/20µs)		Maximum Energy (@10/1000µs)	Maximum Peak Current (@8/20µs)	Rated Power	Typical Capacitance (@1KHz)	Agency Approvals
	ACrms(V)	DC(V)	Vn(V _{DC})	Min.	Max.	Vc(V)	I _p (A)	(J)	(A)	(W)	(pF)	
FMOV20180-D	11	14	18	16	20	36	20	11	2000	0.2	40000	C _{RU} US
FMOV20220-D	14	18	22	20	24	43	20	14	2000	0.2	30000	
FMOV20270-D	17	22	27	24	30	53	20	18	2000	0.2	24500	
FMOV20330-D	20	26	33	30	36	65	20	23	2000	0.2	20000	
FMOV20390-D	25	31	39	35	43	77	20	26	2000	0.2	13800	
FMOV20470-D	30	38	47	42	52	93	20	33	2000	0.2	13500	
FMOV20560-D	35	45	56	50	62	110	20	41	2000	0.2	12200	
FMOV20680-D	40	56	68	61	75	135	20	46	2000	0.2	11500	
FMOV20820-D	50	65	82	74	90	135	100	48	6500	1	8200	
FMOV20101-D	60	85	100	90	110	165	100	51	6500	1	8000	
FMOV20121-D	75	100	120	108	132	200	100	55	6500	1	5500	
FMOV20151-D	95	125	150	135	165	250	100	70	6500	1	4200	
FMOV20181-D	115	150	180	162	198	300	100	85	6500	1	2500	
FMOV20201-D	130	170	200	180	220	340	100	95	6500	1	2300	
FMOV20221-D	140	180	220	198	242	360	100	100	6500	1	2200	
FMOV20241-D	150	200	240	216	264	395	100	108	6500	1	2200	
FMOV20271-D	175	225	270	243	297	455	100	127	6500	1	2100	
FMOV20301-D	195	250	300	270	330	500	100	150	6500	1	1800	
FMOV20331-D	215	275	330	297	363	550	100	163	6500	1	1750	
FMOV20361-D	230	300	360	324	396	595	100	163	6500	1	1700	
FMOV20391-D	250	320	390	351	429	650	100	180	6500	1	1400	
FMOV20431-D	275	350	430	387	473	710	100	190	6500	1	1350	
FMOV20471-D	300	385	470	423	517	775	100	220	6500	1	1200	
FMOV20511-D	320	410	510	459	561	845	100	220	6500	1	1050	
FMOV20561-D	350	460	560	504	616	915	100	220	6500	1	850	
FMOV20621-D	395	510	620	558	682	1020	100	220	6500	1	570	
FMOV20681-D	420	560	680	612	748	1120	100	230	6500	1	550	
FMOV20751-D	465	615	750	675	825	1235	100	255	6500	1	530	
FMOV20781-D	485	640	780	702	858	1290	100	265	6500	1	500	
FMOV20821-D	510	670	820	738	902	1355	100	282	6500	1	500	
FMOV20911-D	550	745	910	819	1001	1500	100	310	6500	1	480	
FMOV20102-D	625	825	1000	900	1100	1650	100	342	6500	1	460	
FMOV20112-D	680	895	1100	990	1210	1815	100	383	6500	1	400	
FMOV20182-D	1000	1465	1800	1620	1980	2950	100	620	6500	1	300	

Transient V-I Characteristic Curves

FMOV05180-D to FMOV-05680-D

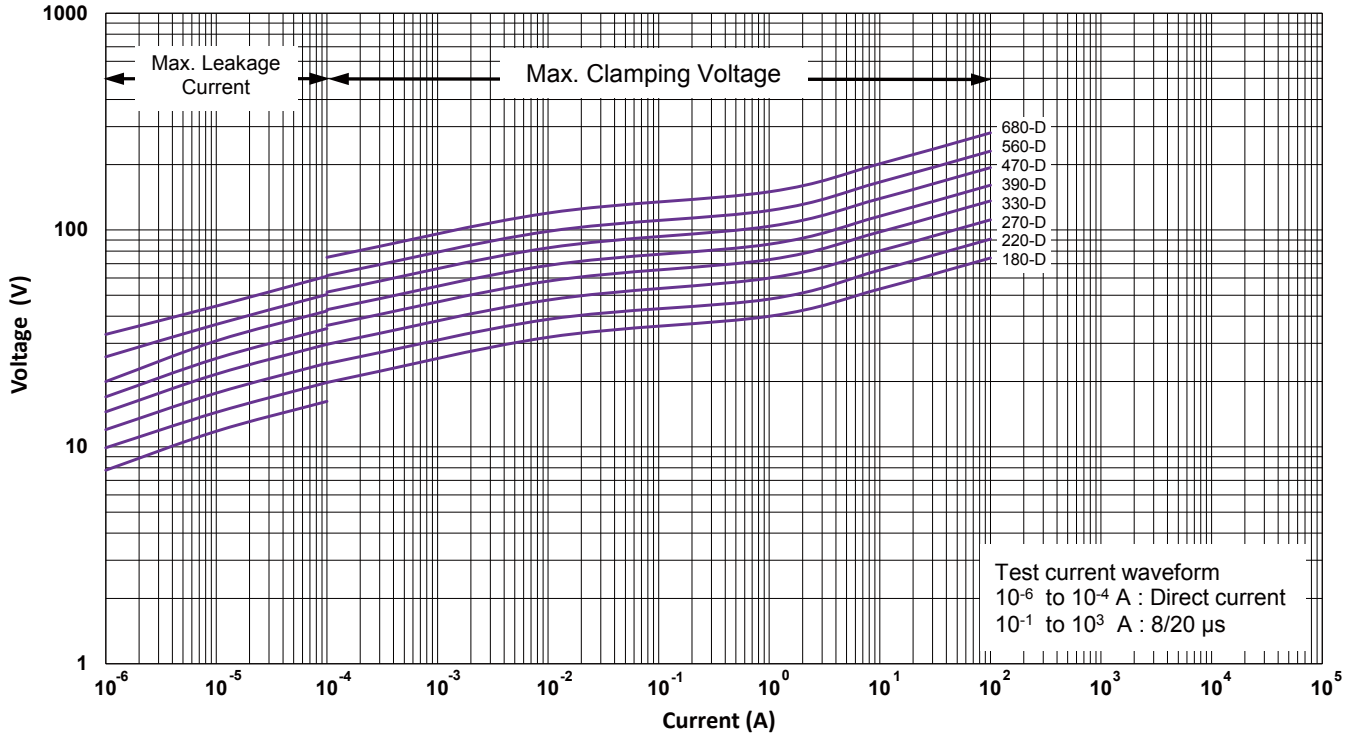

FMOV05820-D to FMOV-05751-D

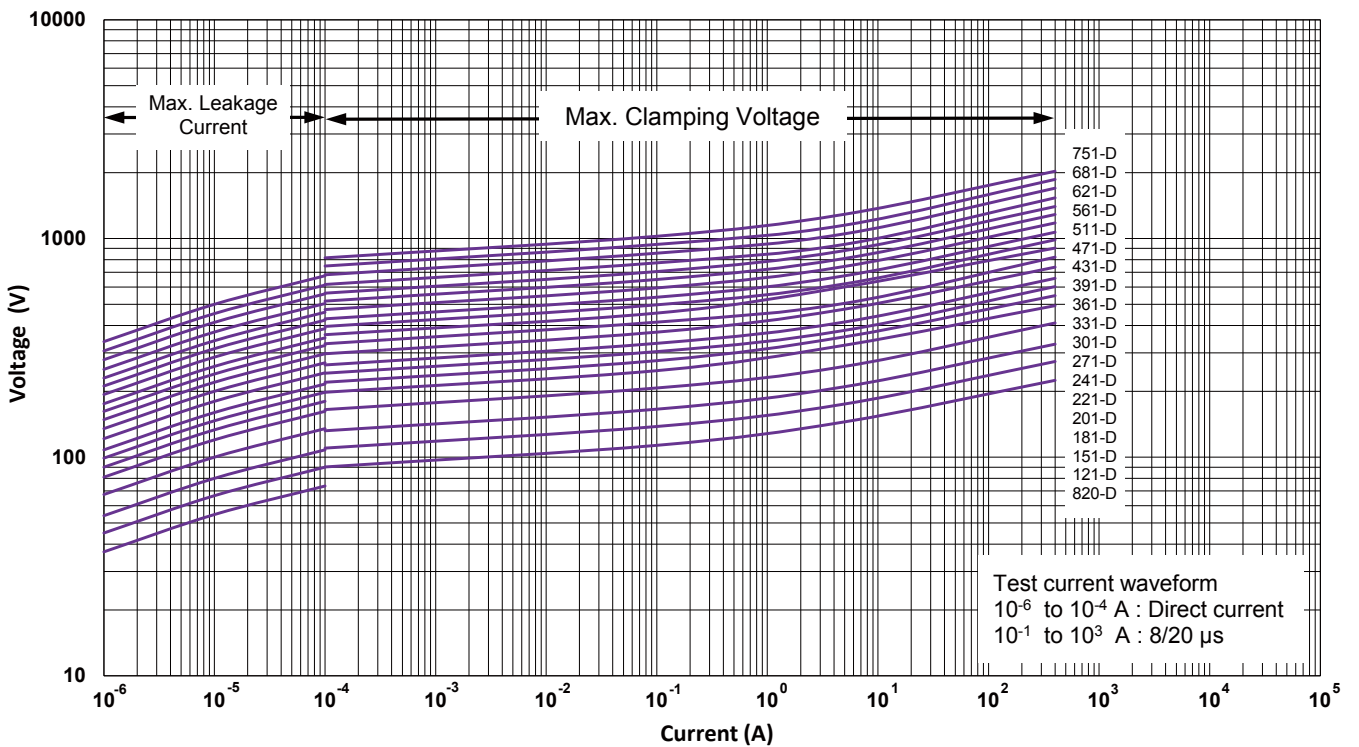

Transient V-I Characteristic Curves

FMOV07180-D to FMOV07680-D

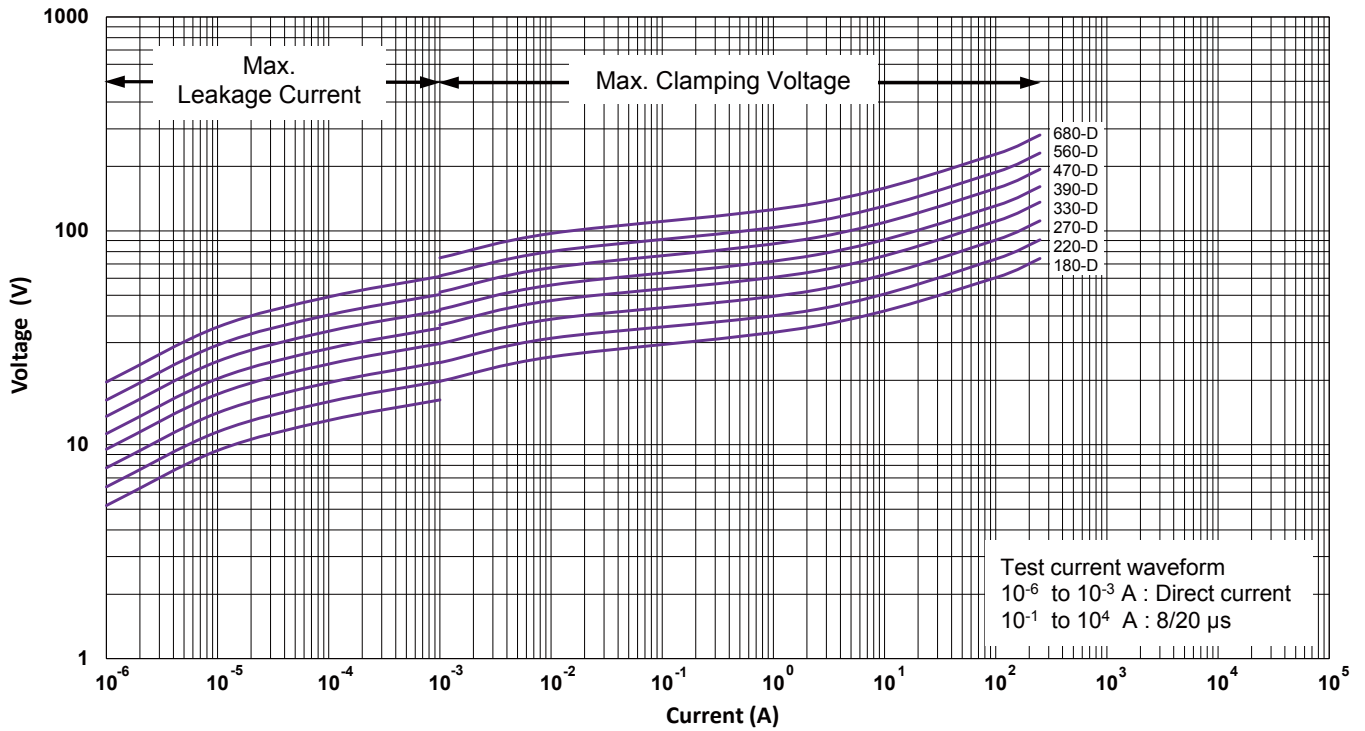

FMOV07820-D to FMOV07471-D

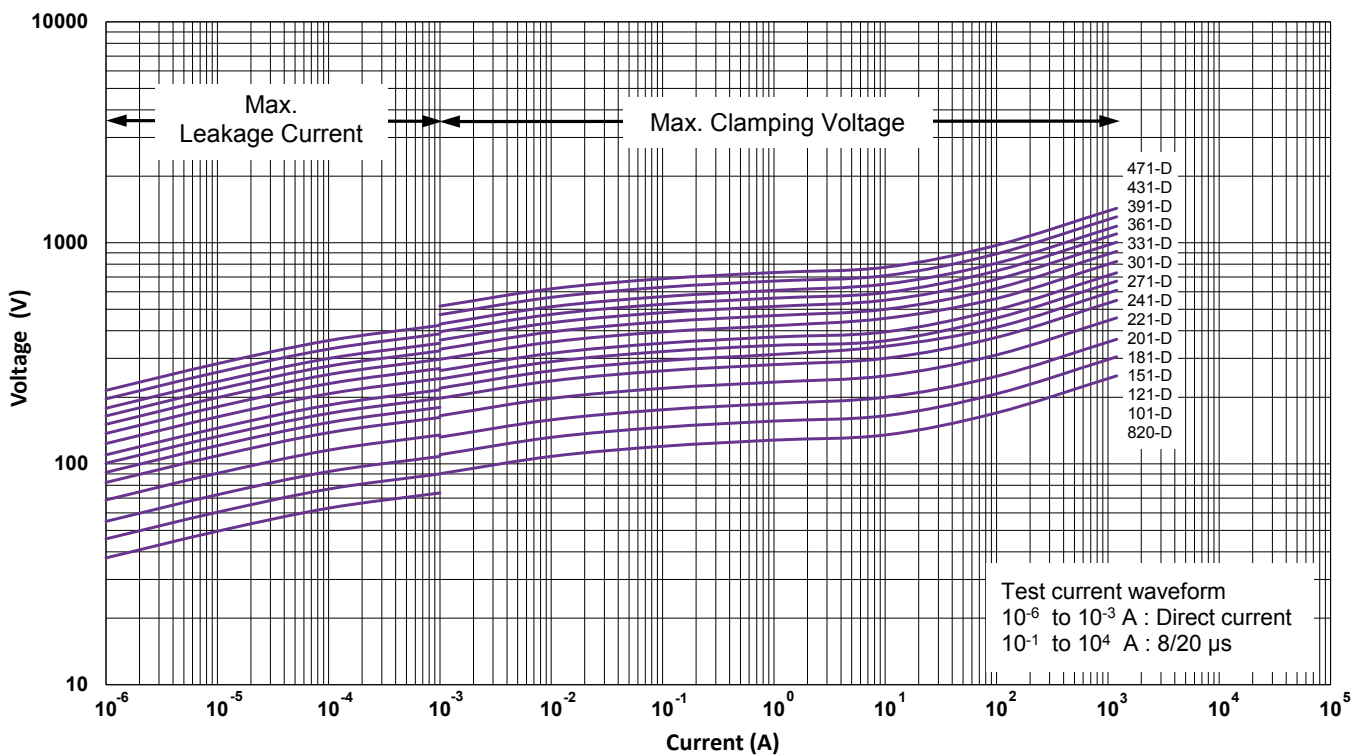

Transient V-I Characteristic Curves

FMOV07511-D to FMOV07821-D

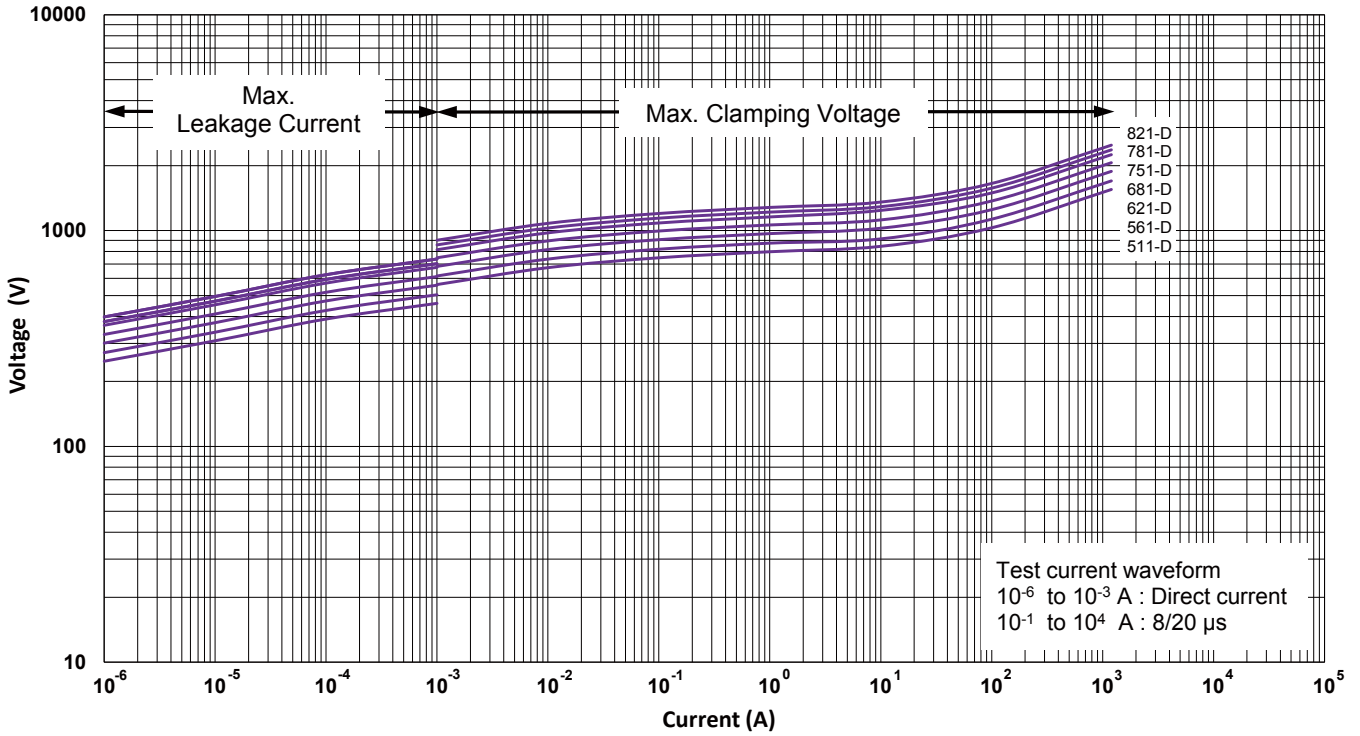

FMOV10180-D to FMOV10680-D

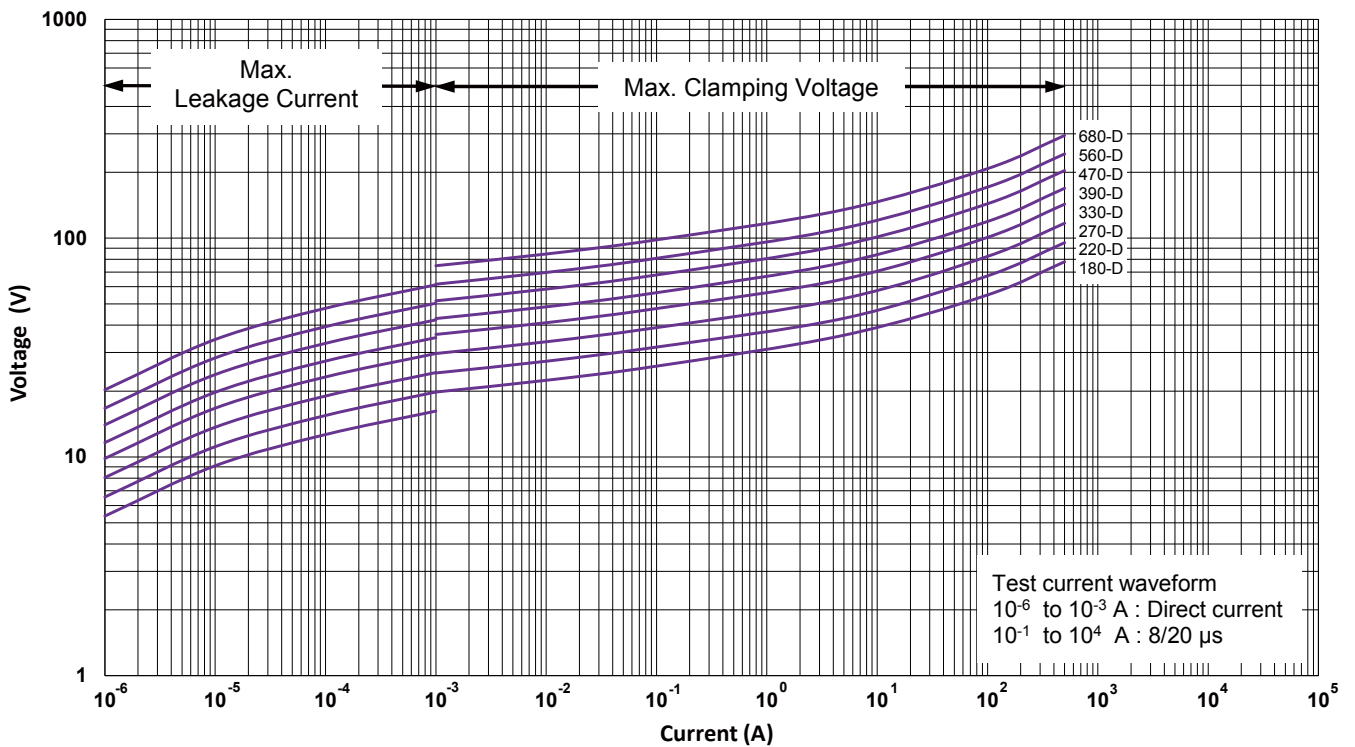

Transient V-I Characteristic Curves

FMOV10820-D to FMOV10471-D

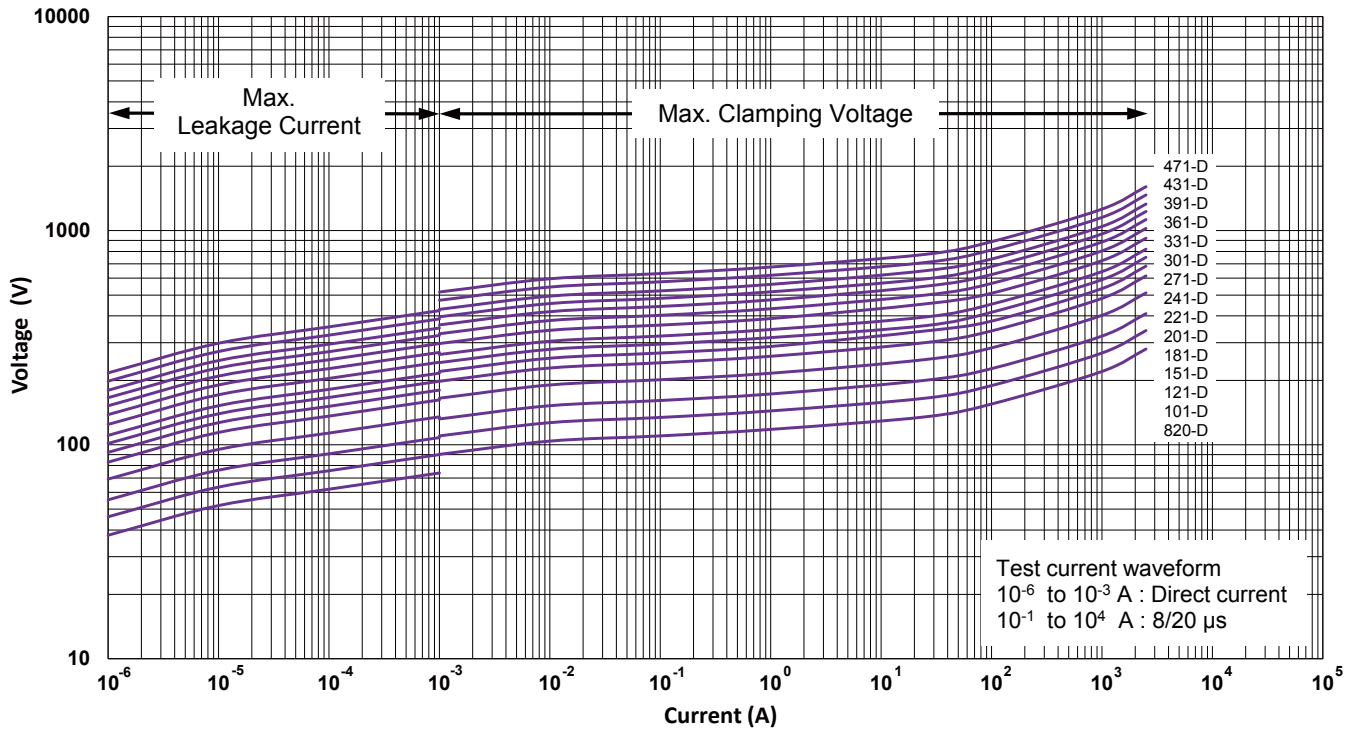

FMOV10511-D to FMOV10182-D

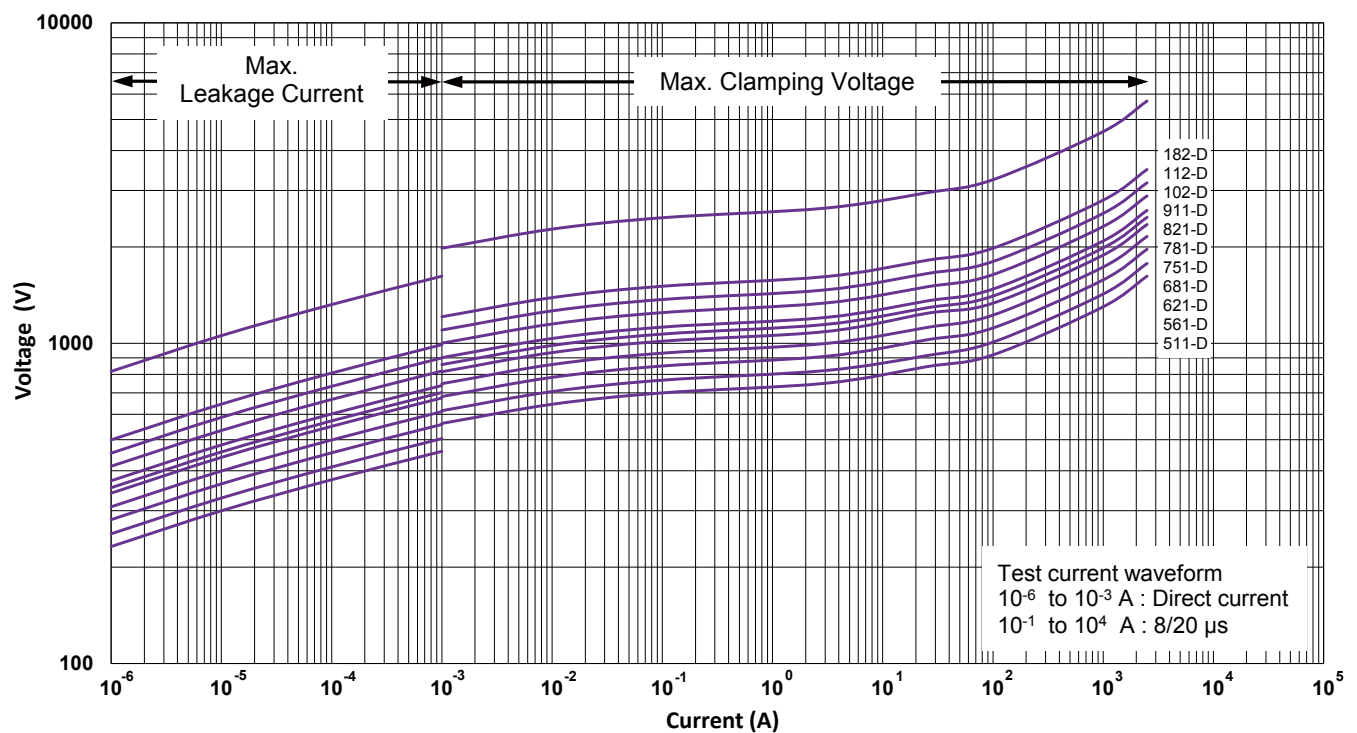

Transient V-I Characteristic Curves

FMOV14180-D to FMOV14680-D

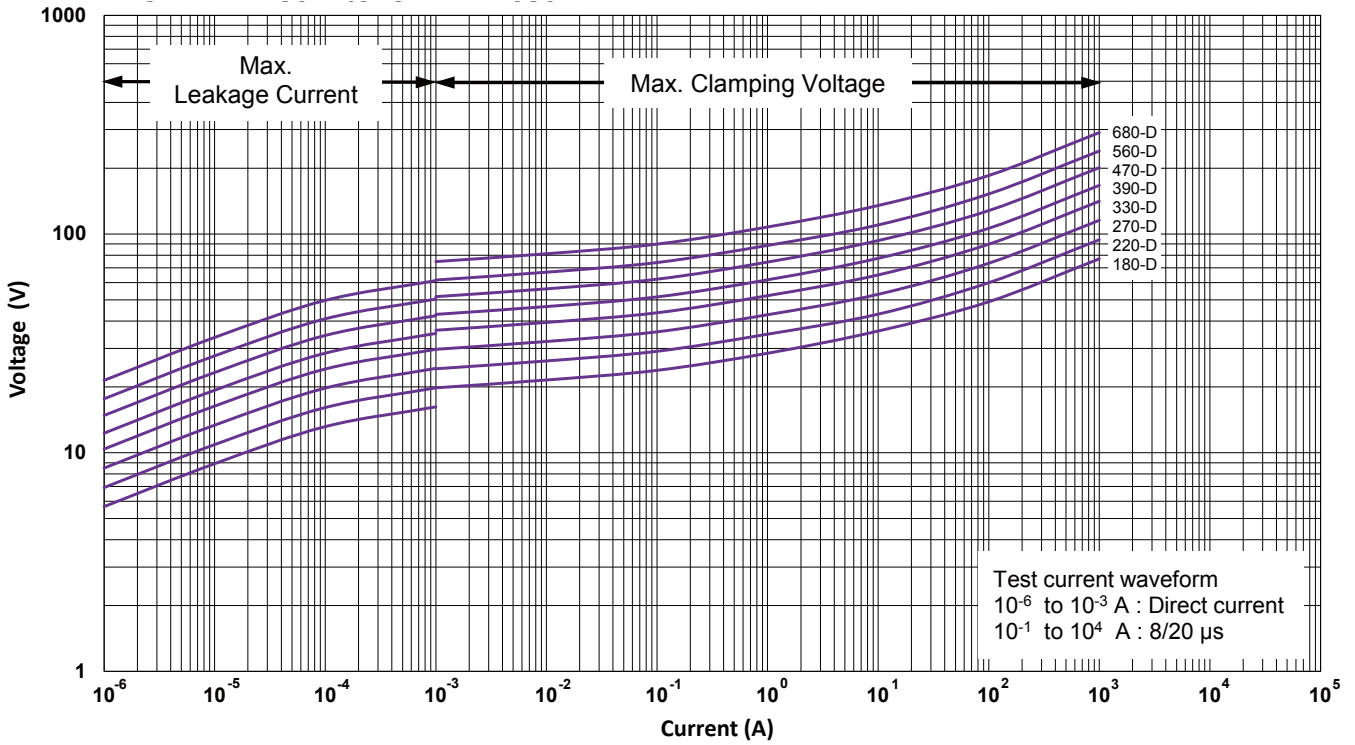

FMOV14820-D to FMOV14471-D

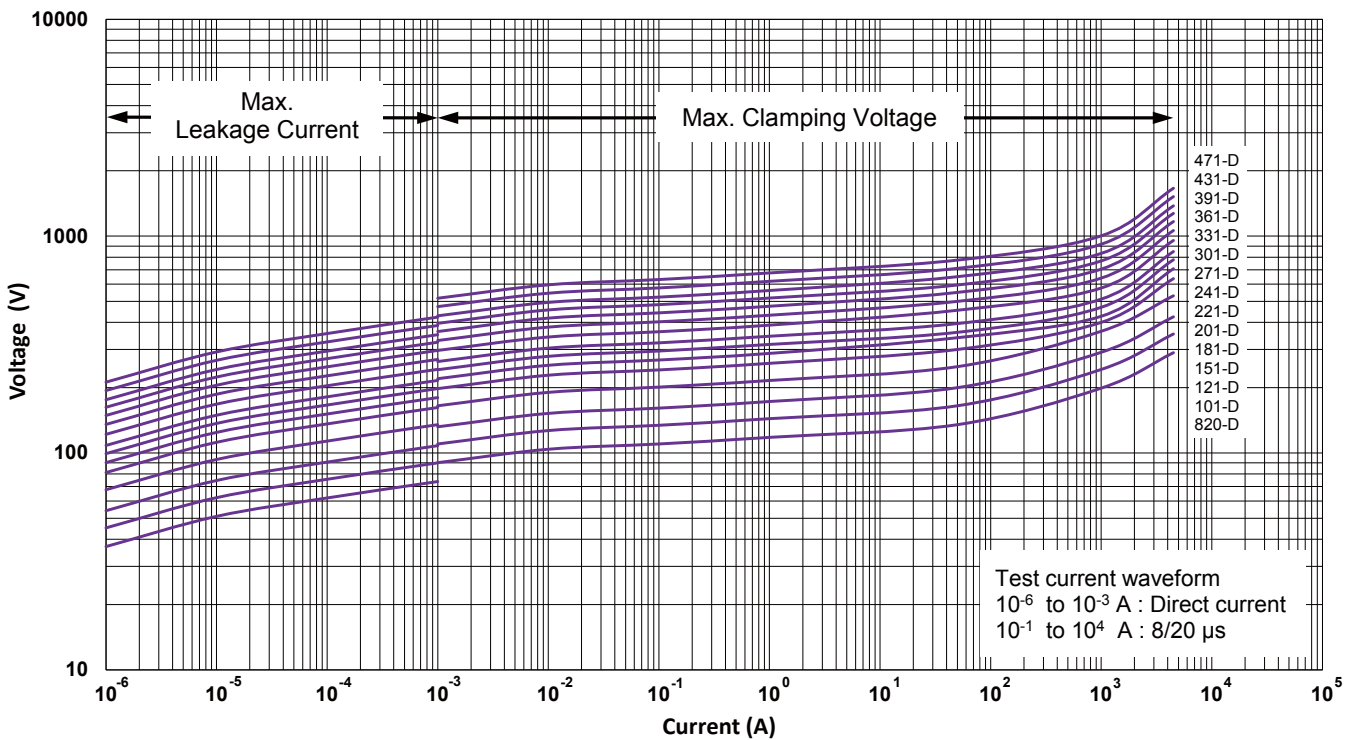

Transient V-I Characteristic Curves

FMOV14511-D to FMOV14182-D

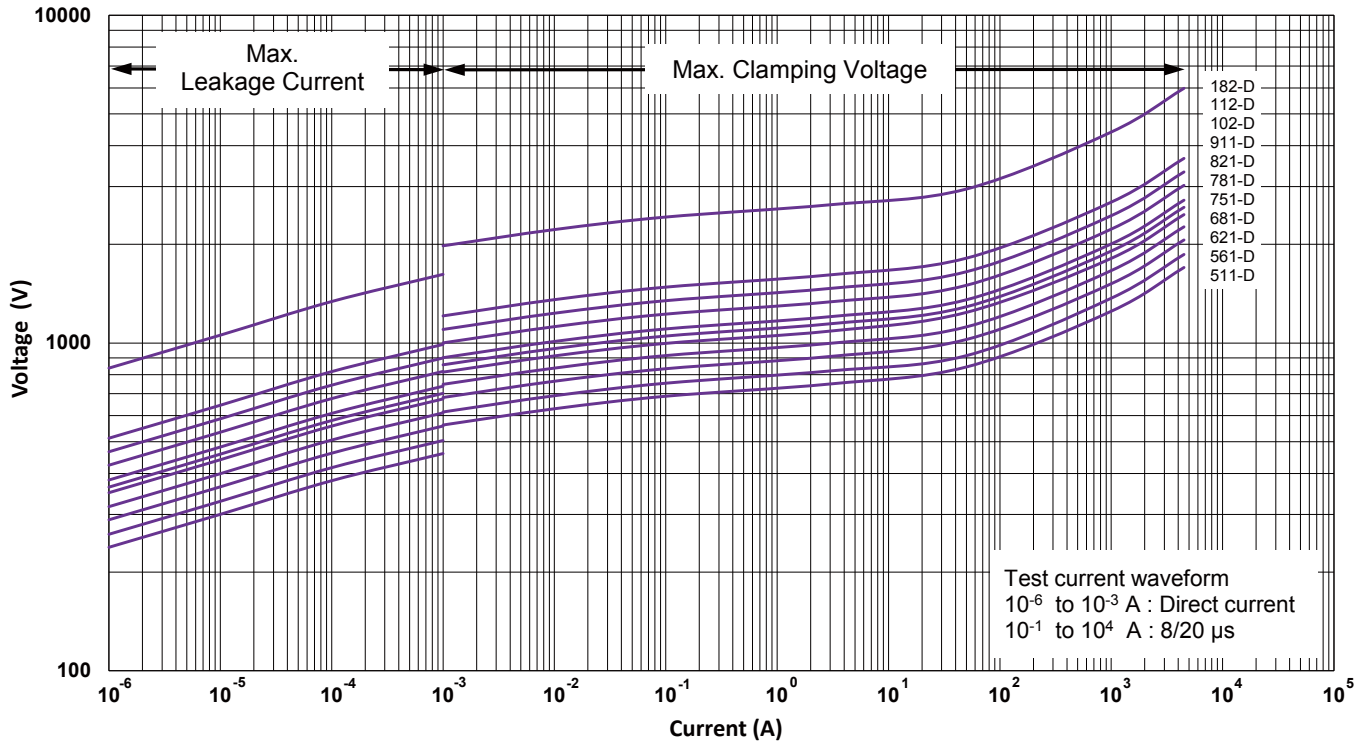

FMOV20180-D to FMOV20680-D

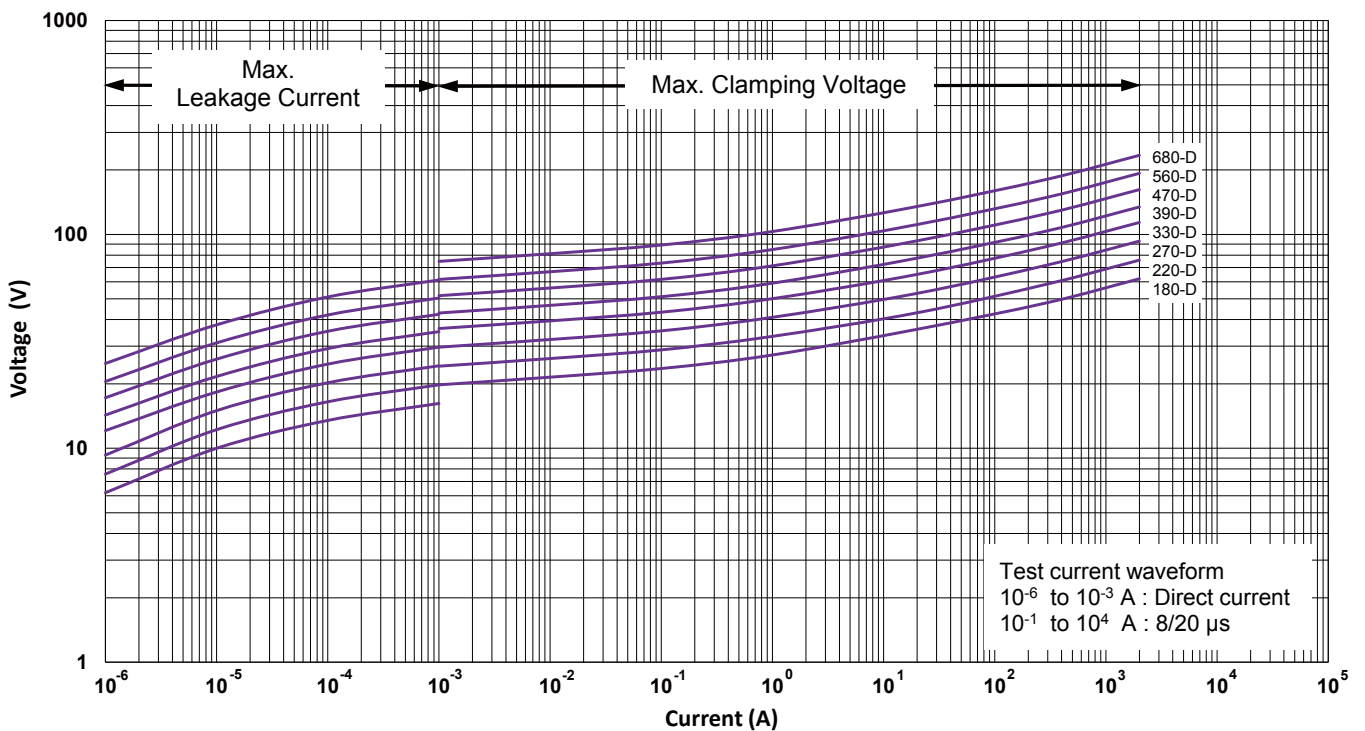

Transient V-I Characteristic Curves

FMOV20820-D to FMOV20471-D

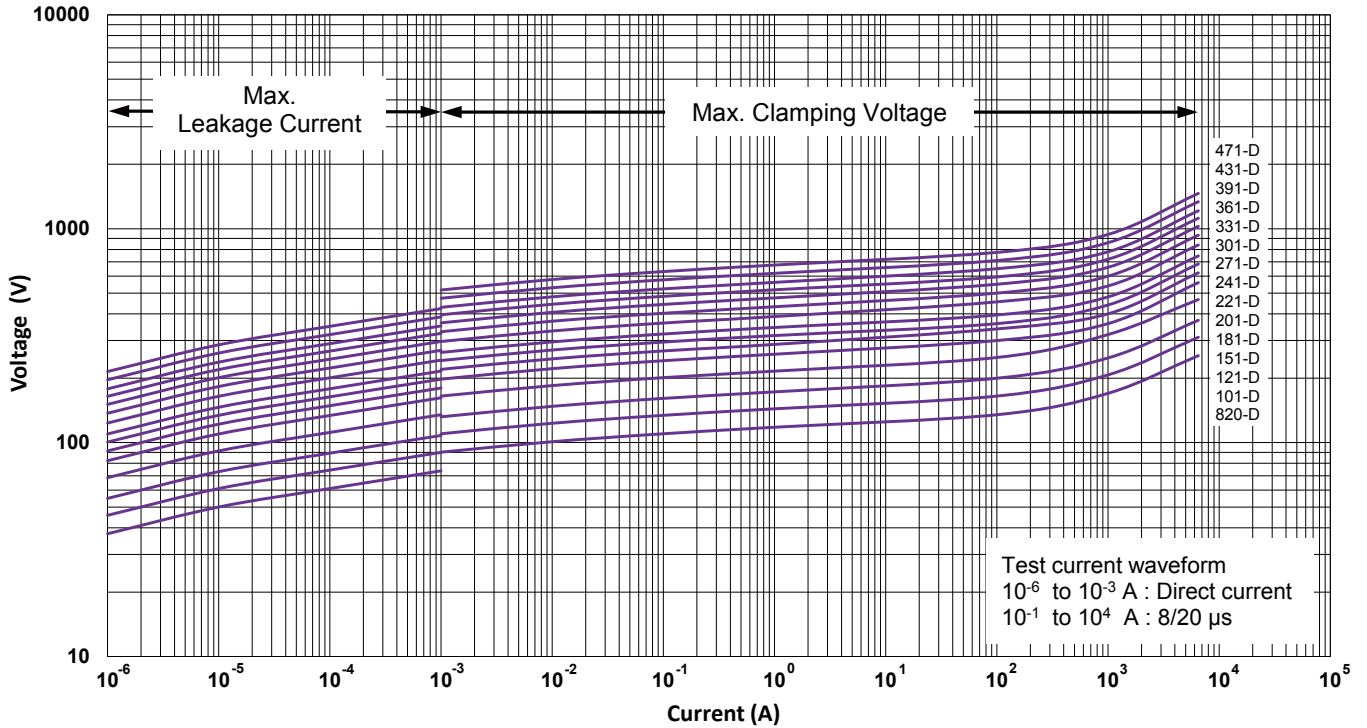

FMOV20511-D to FMOV20182-D

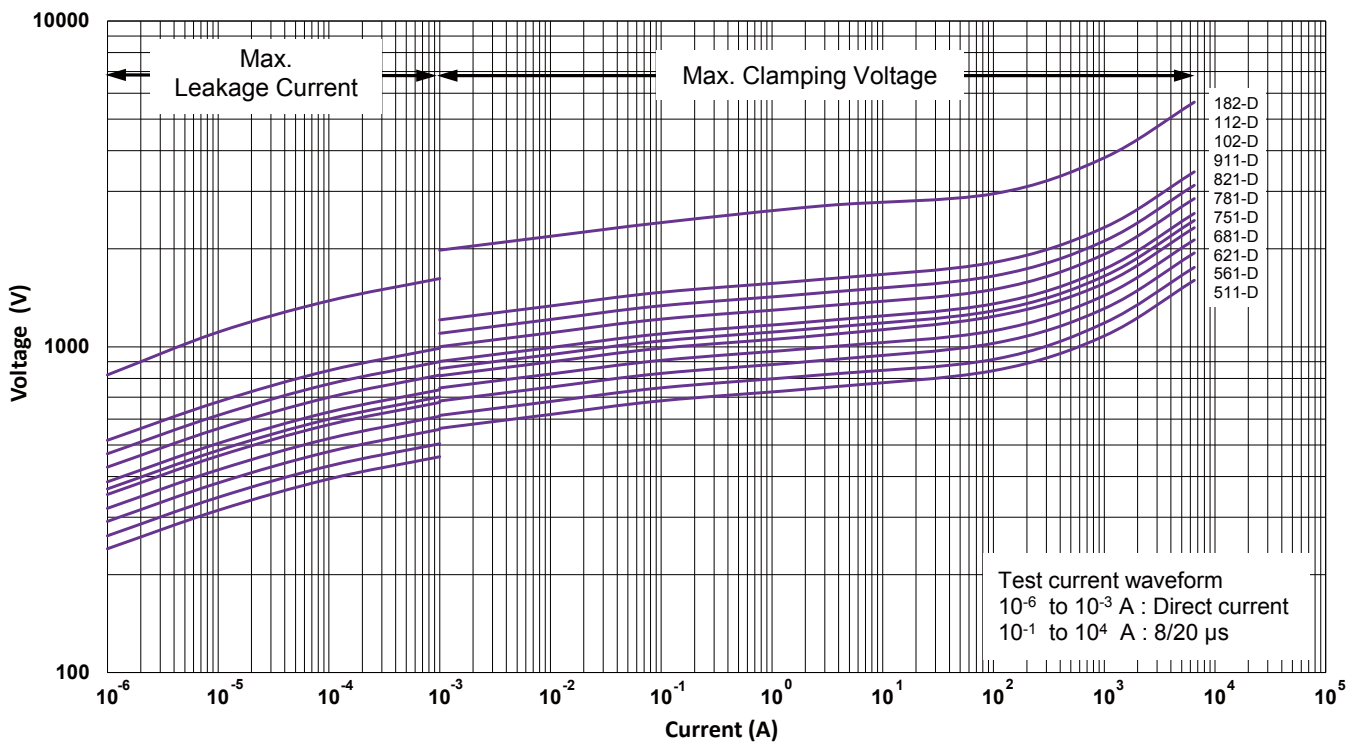

Impulse Life Time Rating Curves

FMOV05180-D to FMOV05680-D

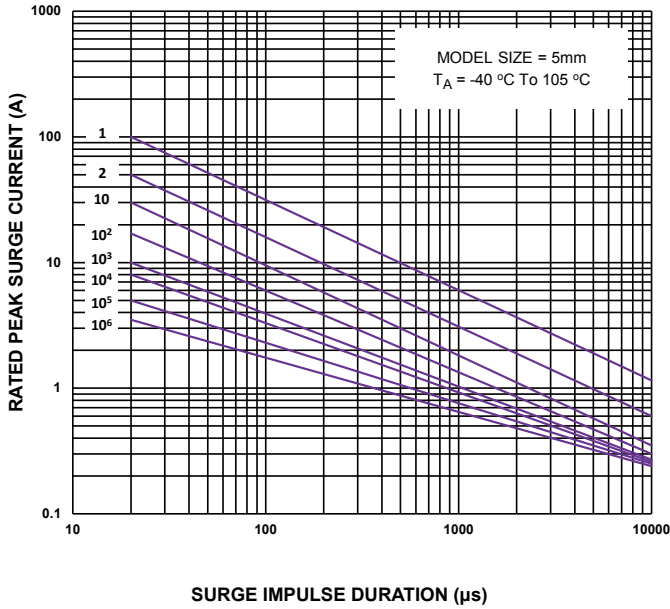

FMOV05820-D to FMOV05751-D

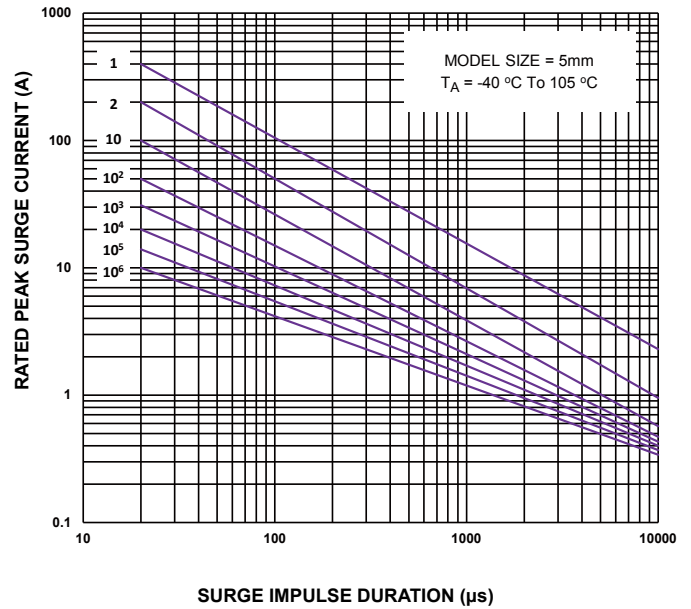

FMOV07180-D to FMOV07680-D

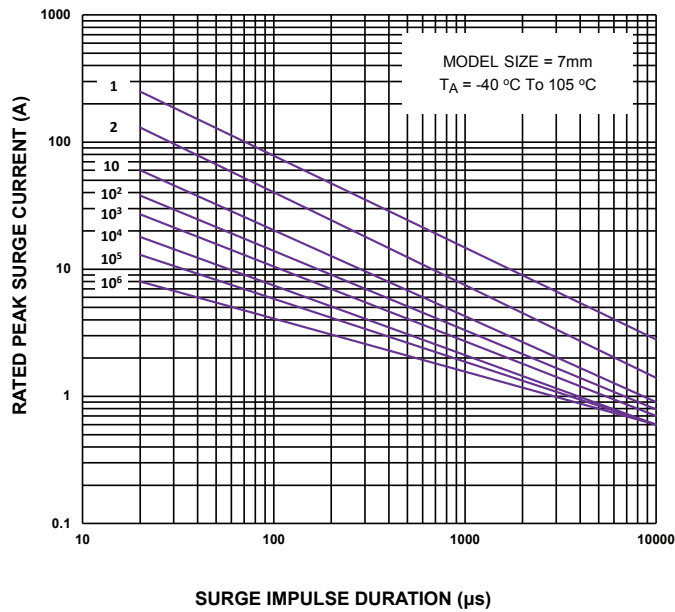

FMOV07820-D to FMOV07821-D

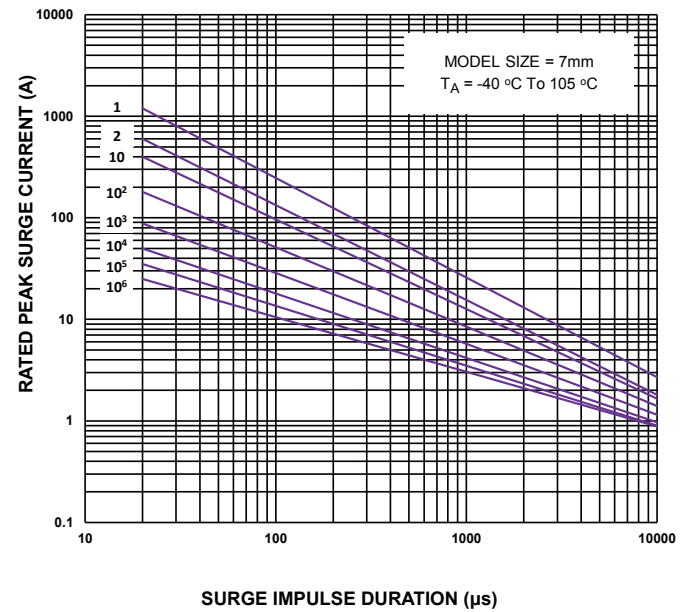

Impulse Life Time Rating Curves

FMOV10180-D to FMOV10680-D

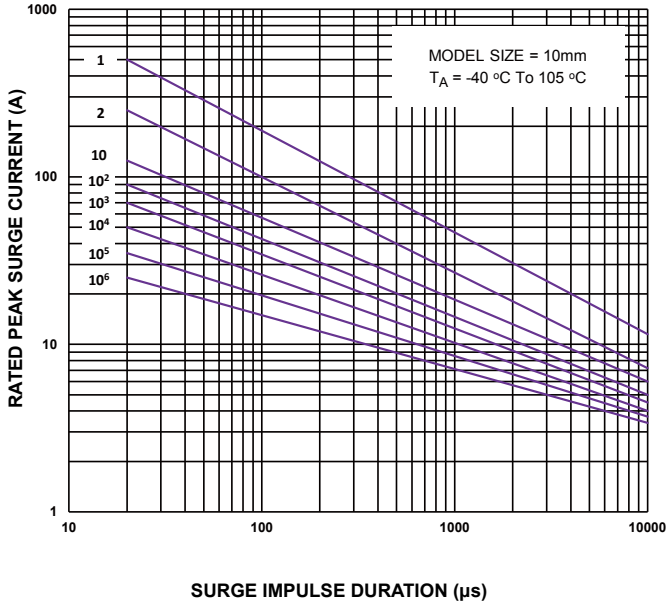

FMOV10820-D to FMOV10751-D

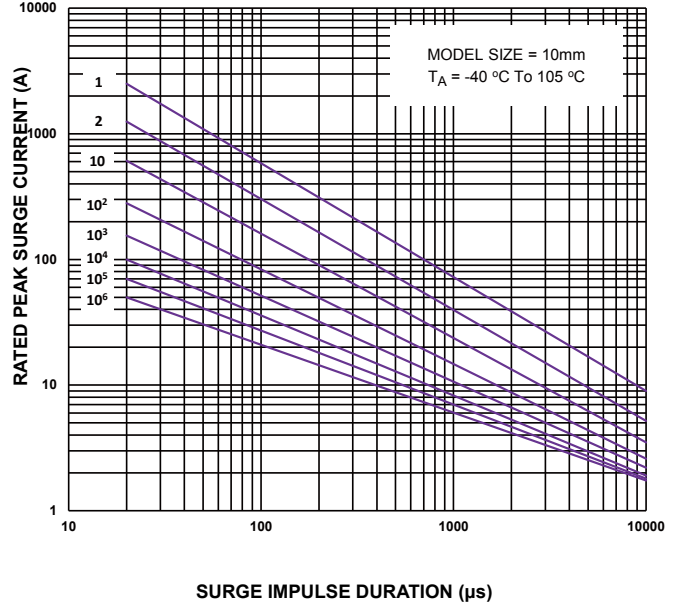

FMOV10781-D to FMOV10182-D

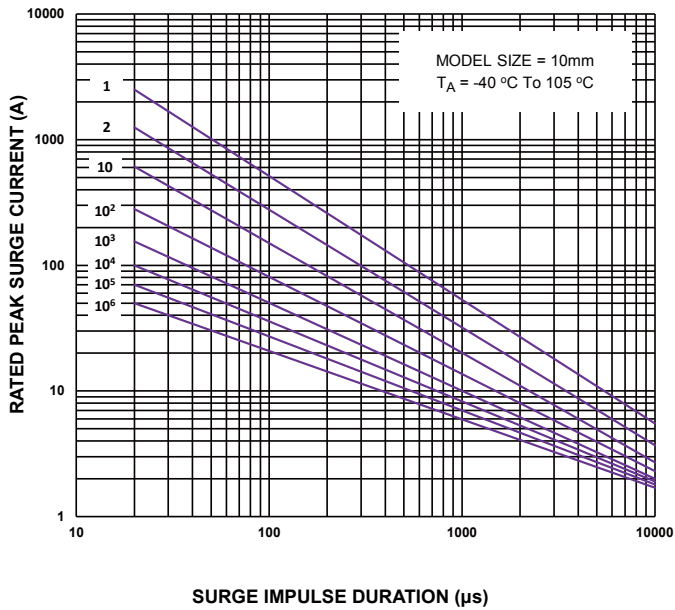

FMOV14180-D to FMOV14680-D

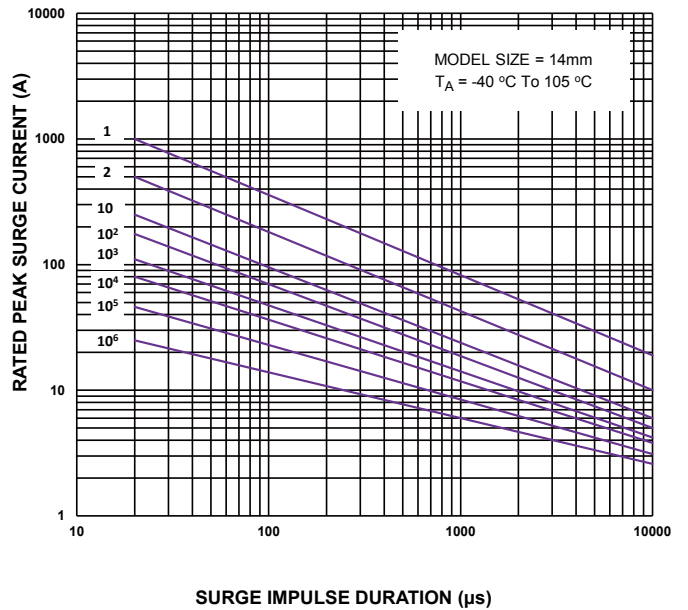

Impulse Life Time Rating Curves

FMOV14820-D to FMOV14751-D

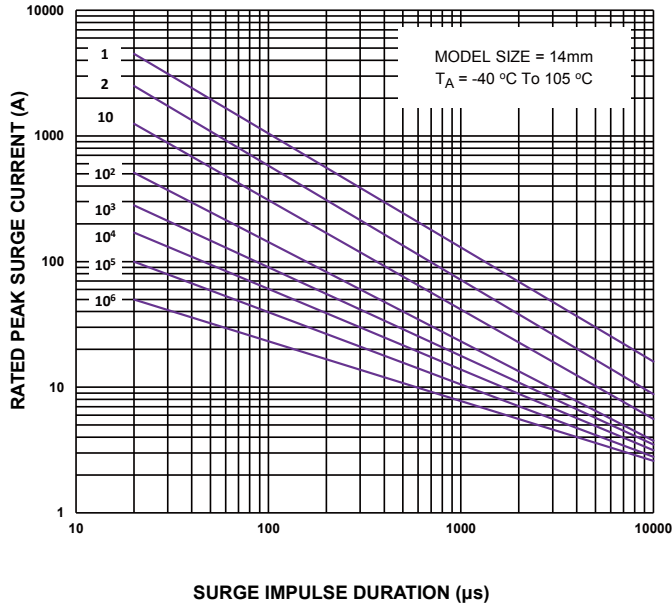

FMOV14781-D to FMOV14182-D

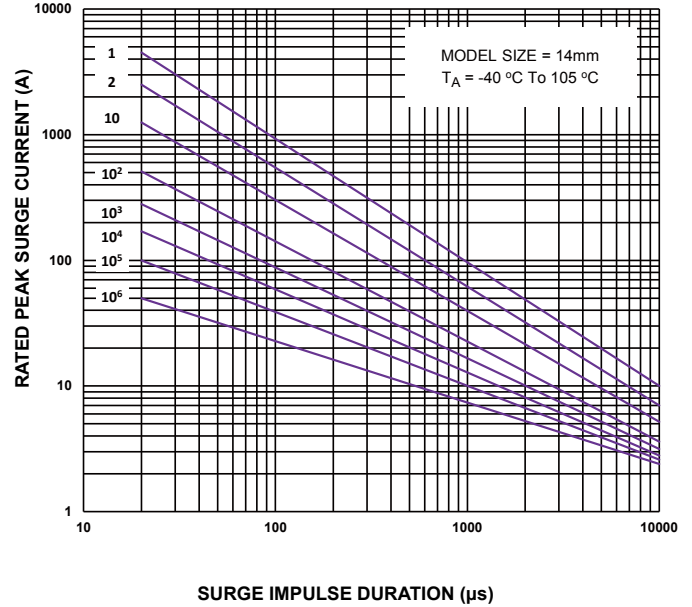

FMOV20180-D to FMOV20680-D

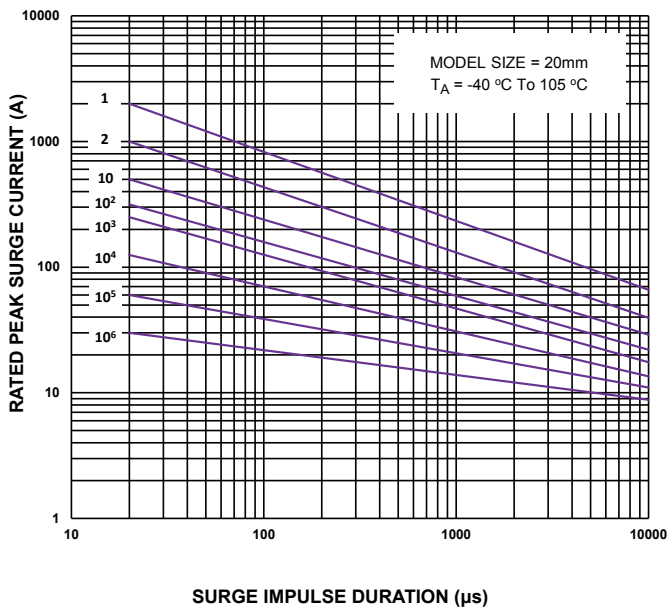

FMOV20820-D to FMOV20751-D

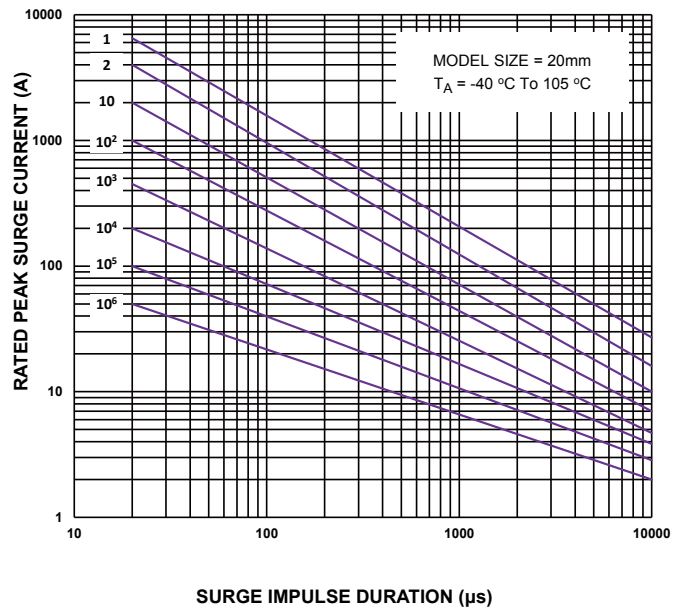

Impulse Life Time Rating Curves

FMOV20781-D to FMOV20182-D

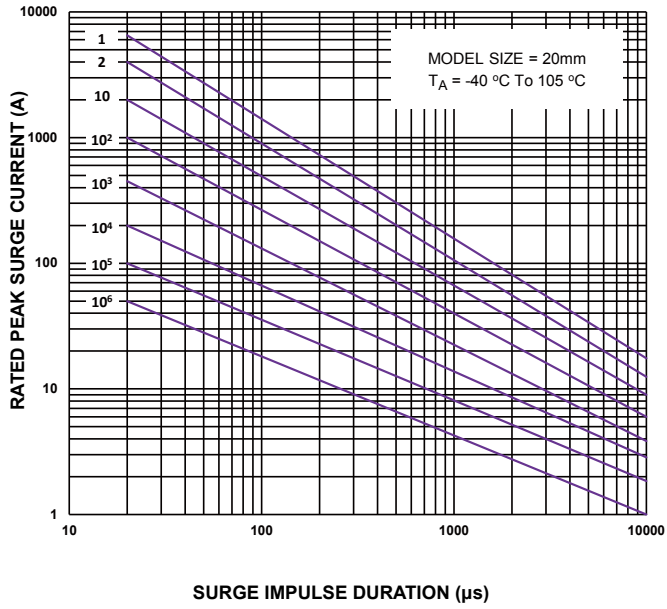

Power Derating Curve

Should transients occur in rapid succession, the average power dissipation is the energy (watt-seconds) per pulse times the number of pulses per second. The power so developed must be with the specifications shown on the Device Ratings and Specifications Table for the specific device. The operating values of a MOV need to be derated at high temperatures as shown above. Because varistors only dissipate a relatively small amount of average power they are not suitable for repetitive applications that involve substantial amounts of average power dissipation.

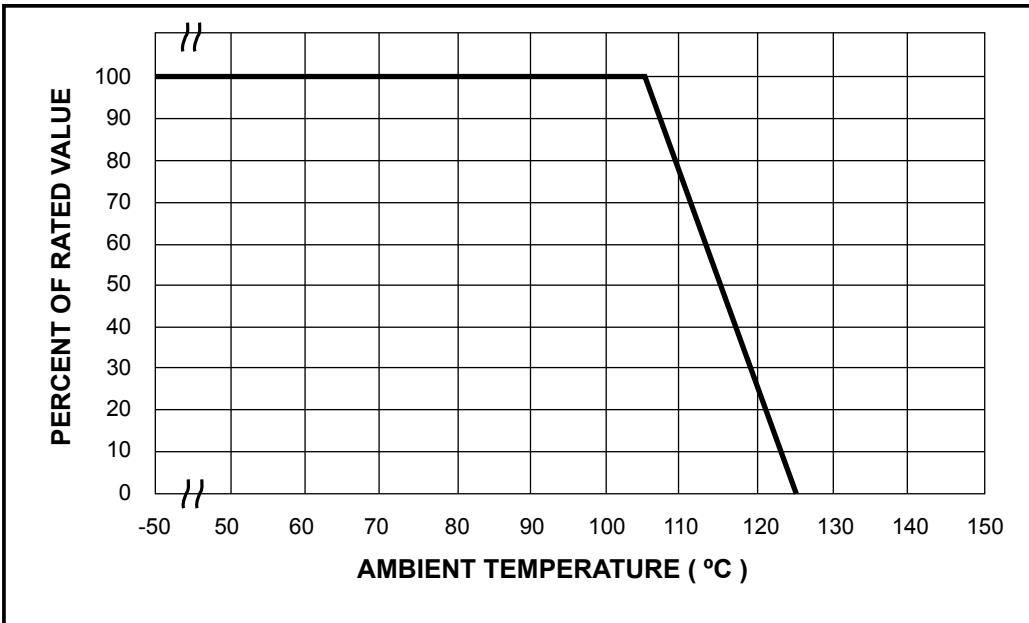

Surge Current Standard Waveform

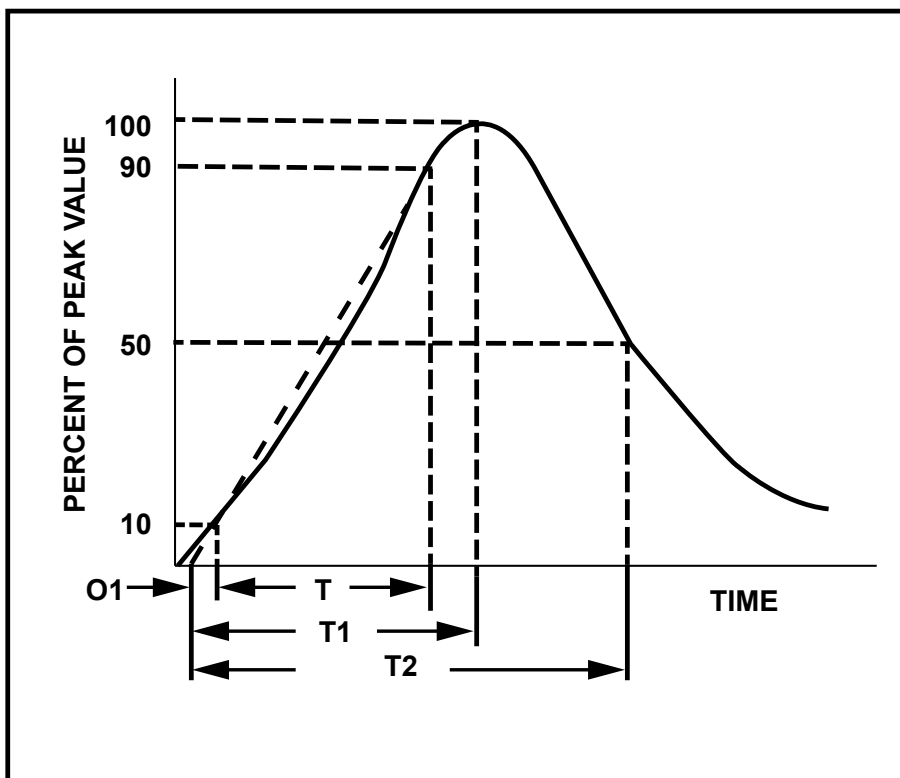

O1 = Virtual Origin of Wave
 T = Time from 10% to 90% of Peak
 $T1 = \text{Rise Time} = 1.25 \times T$
 $T2 = \text{Decay Time}$
 Example - For an 8/20 μs Current Waveform :
 $8\mu\text{s} = T1 = \text{Rise Time}$
 $20\mu\text{s} = T2 = \text{Decay Time}$

Product Dimensions

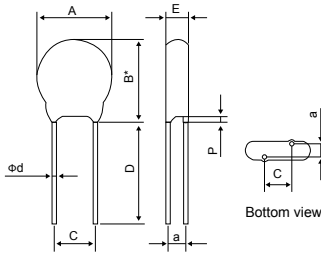

Fig 1. Straight Lead

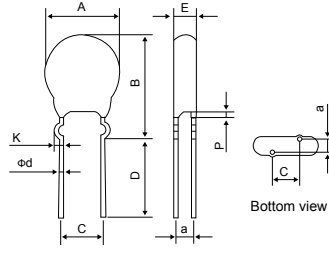

Fig 2. Outside Kink Lead

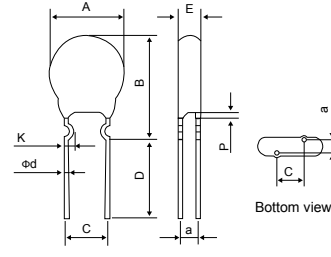

Fig 3. Inside Kink Lead

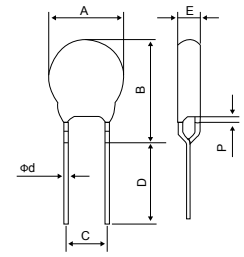

Fig 4. In Line Kink Lead

Dimension Table

Unit : mm

Model size Symbol	05D		07D		10D		14D		20D		
	Min.	Max.	Min.	Max.	Min.	Max.	Min.	Max.	Min.	Max.	
A	5.5	7.5	7.5	9.0	10.5	14.0	13.5	17.5	19.2	25.0	
B(Max.)	180-D ~ 271-D	-	13.0	-	15.0	-	19.5	-	22.5	-	30.0
	>271-D	-	13.0	-	15.0	-	20.5	-	22.5	-	31.0
B*(Max.)	-	10.0	-	12.0	-	17.0	-	20.5	-	28.0	
C(±1.0)	5.0		5.0		7.5		7.5		10.0		
D(Typ.)	25.0		25.0		25.0		25.0		25.0		
P(Max.)	-	3.0	-	3.0	-	3.0	-	3.0	-	3.0	
K	0.8	1.6	0.8	1.6	1.0	1.8	1.0	1.8	1.0	1.8	
Φd(±0.05)	0.60		0.6		0.8		0.8		1.0		
E	E Max. Table										

E Max. Table

Unit : mm

Model	05D	07D	10D	14D	20D	a (±1.0)	Model	05D	07D	10D	14D	20D	a (±1.0)
180-D	3.3	3.5	3.9	4.0	4.4	1.5	301-D	3.9	4.1	4.3	4.4	4.7	1.9
220-D	3.6	3.8	4.2	4.3	4.6	1.6	331-D	4.0	4.2	4.5	4.6	4.9	2.0
270-D	3.8	4.0	4.4	4.5	4.8	1.7	361-D	4.1	4.3	4.7	4.8	5.1	1.7
330-D	3.3	3.5	3.9	4.0	4.9	1.6	391-D	4.2	4.4	4.8	4.9	5.2	1.8
390-D	3.5	3.7	4.1	4.2	5.1	1.8	431-D	4.4	4.6	5.0	5.1	5.4	1.9
470-D	3.7	3.9	4.3	4.4	5.3	1.9	471-D	4.6	4.8	5.2	5.3	5.6	2.0
560-D	4.0	4.2	4.6	4.7	5.4	2.0	511-D	4.8	5.0	5.3	5.4	5.7	2.2
680-D	4.3	4.5	4.9	5.0	5.6	2.2	561-D	5.0	5.2	5.5	5.6	5.9	2.3
820-D	3.3	3.5	3.9	4.0	5.8	1.5	621-D	5.3	5.5	5.7	5.8	6.1	2.5
101-D	3.6	3.8	4.2	4.3	5.9	1.5	681-D	5.4	5.6	5.8	5.9	6.2	2.7
121-D	3.8	4.0	4.4	4.5	6.1	1.6	751-D	5.6	5.8	6.0	6.1	6.4	2.9
151-D	4.1	4.3	4.7	4.8	6.4	1.8	778-D	-	6.0	6.3	6.4	6.7	3.0
181-D	3.2	3.4	3.8	3.9	6.6	1.5	821-D	-	6.3	6.5	6.6	6.9	3.1
201-D	3.3	3.5	3.9	4.0	6.7	1.5	911-D	-	-	6.6	6.7	7.0	3.5
221-D	3.4	3.6	4.0	4.1	7.1	1.6	102-D	-	-	7.0	7.1	7.4	3.8
241-D	3.5	3.7	4.1	4.2	7.5	1.7	112-D	-	-	7.4	7.5	7.9	4.1
271-D	3.7	3.9	4.2	4.3	11.5	1.8	182-D	-	-	11.3	11.5	11.9	6.0

Part Numbering and Marking System

Part Numbering System :

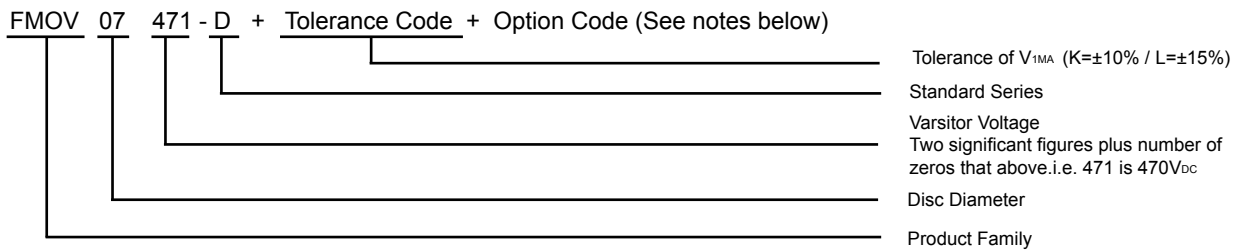

Marking System :

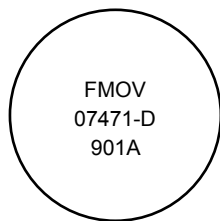

Example

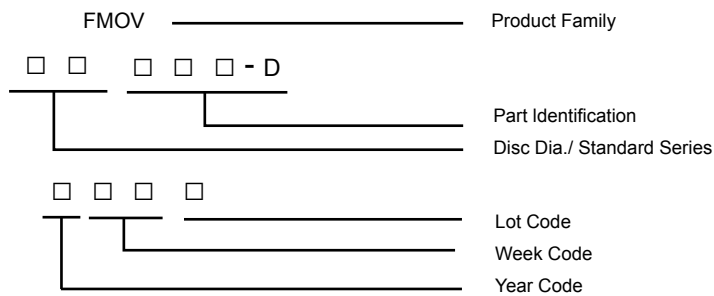

Order Notes

Main Part Code :

Part No + Tolerance Code + Packaging + Lead Type Designators + Option Code

Ordering examples :

Straight Lead Bulk Pack (Standard)	Straight Lead (Short Cut) Bulk Pack	Straight Lead Tape & Reel Pack	Straight Lead Flat Box Pack	Tape & Reel Pack Feed Hole Pitch
FMOV05471-DKBS	FMOV05471-DKBSXXX	FMOV05471-DKTS	FMOV05471-DKAS	FMOV05471-DKTSA
FMOV07471-DKBS	FMOV07471-DKBSXXX	FMOV07471-DKTS	FMOV07471-DKAS	FMOV05471-DKTSB
FMOV10471-DKBS	FMOV10471-DKBSXXX	FMOV10471-DKTS	FMOV10471-DKAS	FMOV07471-DKTSA
FMOV14471-DKBS	FMOV14471-DKBSXXX	FMOV14471-DKTS	FMOV14471-DKAS	FMOV07471-DKTSB
FMOV20471-DKBS	FMOV20471-DKBSXXX	-	-	FMOV10471-DKTSA
				FMOV10471-DKTSB
				FMOV14471-DKTSA
				FMOV14471-DKTSB

Outside Kink Lead Bulk Pack	Outside Kink lead (Short Cut) Bulk Pack	Outside Kink Lead Tape & Reel Pack	Outside Kink Lead Flat Box Pack
FMOV05471-DKBO	FMOV05471-DKBOXXX	FMOV05471-DKTO	FMOV05471-DKAO
FMOV07471-DKBO	FMOV07471-DKBOXXX	FMOV07471-DKTO	FMOV07471-DKAO
FMOV10471-DKBO	FMOV10471-DKBOXXX	FMOV10471-DKTO	FMOV10471-DKAO
FMOV14471-DKBO	FMOV14471-DKBOXXX	FMOV14471-DKTO	FMOV14471-DKAO
FMOV20471-DKBO	FMOV20471-DKBOXXX	-	-

Inside Kink lead Bulk Pack	Inside Kink Lead (Short Cut) Bulk Pack	Inside Kink Lead Tape & Reel Pack	Inside Kink Lead Flat Box Pack
FMOV05471-DKBK	FMOV05471-DKBKXXX	FMOV05471-DKTK	FMOV05471-DKAK
FMOV07471-DKBK	FMOV07471-DKBKXXX	FMOV07471-DKTK	FMOV07471-DKAK
FMOV10471-DKBK	FMOV10471-DKBKXXX	FMOV10471-DKTK	FMOV10471-DKAK
FMOV14471-DKBK	FMOV14471-DKBKXXX	FMOV14471-DKTK	FMOV14471-DKAK
FMOV20471-DKBK	FMOV20471-DKBKXXX	-	-

In Line Kink Lead Bulk Pack	In Line Kink Lead (Short Cut) Bulk Pack	In Line Kink Lead Tape & Reel Pack	In Line Kink Lead Flat Box Pack
FMOV05471-DKBI	FMOV05471-DKBIXXX	FMOV05471-DKTI	FMOV05471-DKAI
FMOV07471-DKBI	FMOV07471-DKBIXXX	FMOV07471-DKTI	FMOV07471-DKAI
FMOV10471-DKBI	FMOV10471-DKBIXXX	FMOV10471-DKTI	FMOV10471-DKAI
FMOV14471-DKBI	FMOV14471-DKBIXXX	FMOV14471-DKTI	FMOV14471-DKAI
FMOV20471-DKBI	FMOV20471-DKBIXXX	-	-

A : P0 → 12.7mm±0.2mm
B : P0 → 15.0mm±0.2mm

Tape and Reel Specifications

Radial devices on tape are supplied with straight leads or inline kink leads

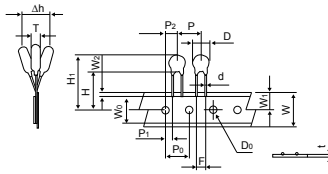

Figure: A

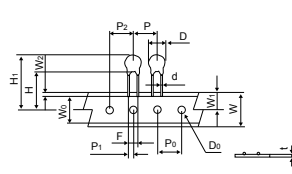

Figure: B

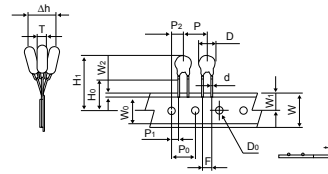

Figure: C

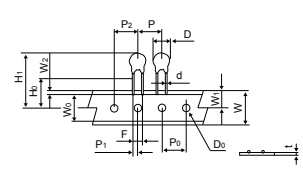

Figure: D

Straight Leads

Inline Kink Leads

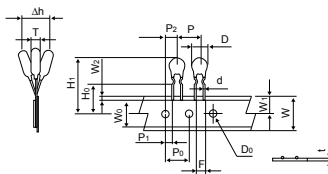

Figure: E

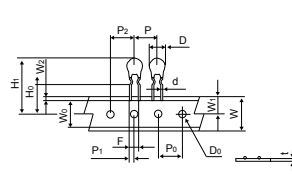

Figure: F

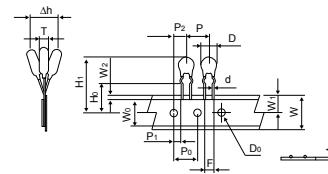

Figure: G

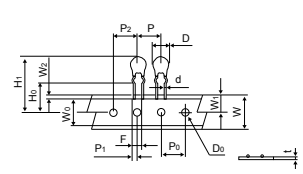

Figure: H

Inside Kink Leads

Outside Kink Leads

Symbol	Parameter	Model					
		05D	07D	10D	15D	25D	30D
P	Pitch of Component	12.7±1.0	12.7±1.0	12.7±1.0	15.0±1.0	25.4±1.0	30.0±1.0
P0	Feed Hole Pitch	12.7±0.2	12.7±0.2	12.7±0.2	15.0±0.2	12.7±0.2	15.0±0.2
P1	Feed Hole Center Lead	3.85±0.7	3.85±0.7	3.85±0.7	3.75±0.7	8.95±0.7	3.75±0.7
P2	Hole center to Component Center	6.35±0.7	6.35±0.7	6.35±0.7	7.5±0.7	12.7±0.7	7.5±0.7
F	Lead to Lead Distance	5.0±0.8	5.0±0.8	7.5±0.8	7.5±0.8	7.5±0.8	7.5±0.8
Δh	Component Alignment	2.0 Max	2.0 Max	2.0 Max	2.0 Max	2.0 Max	2.0 Max
W	Tape Width	18.0+1.0	18.0+1.0	18.0+1.0	18.0+1.0	18.0+1.0	18.0+1.0
		18.0-0.5	18.0-0.5	18.0-0.5	18.0-0.5	18.0-0.5	18.0-0.5
W0	Hold Down Tape Width	5.0 Min	5.0 Min	5.0 Min	5.0 Min	5.0 Min	5.0 Min
W1	Hole Position	9.0+0.75	9.0+0.75	9.0+0.75	9.0+0.75	9.0+0.75	9.0+0.75
		9.0-0.50	9.0-0.50	9.0-0.50	9.0-0.50	9.0-0.50	9.0-0.50
W2	Hold Down Tape Position	3.0 Max	3.0 Max	3.0 Max	3.0 Max	3.0 Max	3.0 Max
H	Height from Tape Center to Component Base	18.0+2.0	18.0+2.0	18.0+2.0	18.0+2.0	18.0+2.0	18.0+2.0
		18.0-0.0	18.0-0.0	18.0-0.0	18.0-0.0	18.0-0.0	18.0-0.0
H0	Seating Plane Height	16.0±0.5	16.0±0.5	16.0±0.5	16.0±0.5	16.0±0.5	16.0±0.5
H1	Component Height	29.0 Max	32.0 Max	36.0 Max	36.0 Max	40.0 Max	40.0 Max
D0	Feed Hole Diameter	4.0±0.2	4.0±0.2	4.0±0.2	4.0±0.2	4.0±0.2	4.0±0.2
t	Total Tape Thickness	0.7±0.2	0.7±0.2	0.7±0.2	0.7±0.2	0.7±0.2	0.7±0.2
L	Length of Clipped Lead	11.0 Max	11.0 Max	11.0 Max	11.0 Max	11.0 Max	11.0 Max
Figure		ACEG	ACEG	BDFH	ACEG	BDFH	ACEG

Unit: mm

Packaging Specifications

Bulk Product Packing

Series	Straight Lead Type Quantity (pcs/bag)	Outside Kink Lead Type Quantity (pcs/bag)	Inside Kink Lead Type Quantity (pcs/bag)	In Line Kink Lead Type Quantity (pcs/bag)
FMOV05-D Series	1000	1000	1000	1000
FMOV07-D Series	1000	1000	1000	1000
FMOV10-D Series	500	500	500	500
FMOV14-D Series	500	500	500	500
FMOV20-D Series	250	250	250	250

Tape & Reel Product Packing

Series	A (mm)	Quantity (pcs/reel)
FMOV05(180~391)-D-T-	43	2000
FMOV05(431~751)-D-T-		1500
FMOV07(180~391)-D-T-		2000
FMOV07(431~821)-D-T-		1500
FMOV10(180~621)-D-T-		1000
FMOV10(681~112)-D-T-		800
FMOV14(180~391)-D-T-	56	800
FMOV14(431~621)-D-T-		700
FMOV14(681~112)-D-T-		600

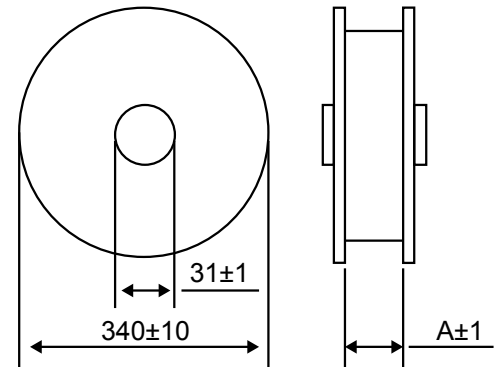

Box Product Packing

Series	Quantity (pcs/reel)
FMOV05(180~621)-D-A-	1000
FMOV05(681~751)-D-A-	800
FMOV07(180~391)-D-A-	1000
FMOV07(431~821)-D-A-	800
FMOV10(180~621)-D-A-	1000
FMOV10(681~112)-D-A-	800
FMOV14(180~621)-D-A-	500
FMOV14(681~112)-D-A-	400

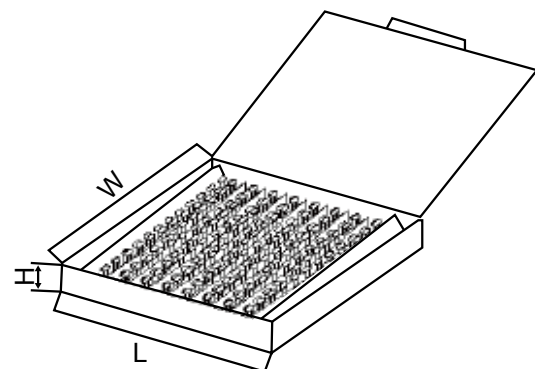

Series	L ± 5	W ± 5	H ± 5
FMOV05~07-D Series	340	245	45
FMOV10~14-D Series	340	245	50

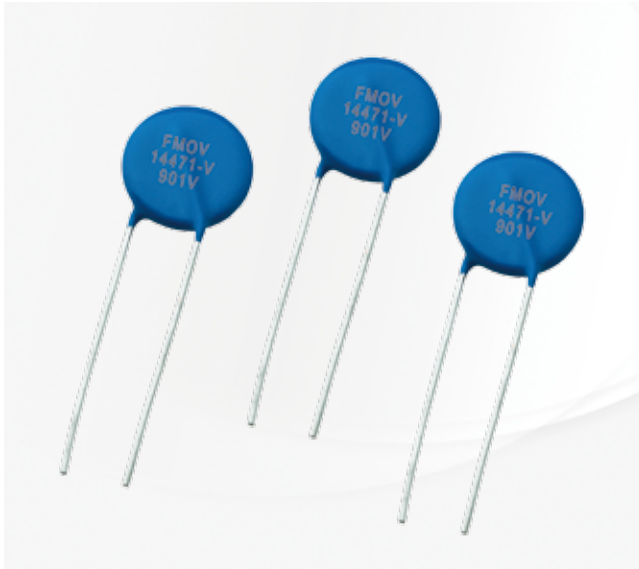

Description :

Fuzetec V Series Metal Oxide Varistors (MOV) are designed for applications which require medium level of surge protection. They are ideal for AC Line Voltage applications, inductive load switching and products that require voltage clamping of higher transient surge currents from power sources. MOV products have specific nonlinear and symmetrical V-I characteristics curve and unparalleled large peak current capability are used for absorption of transient voltage, suppression of pulse noise and circuit voltage stabilization.

Agency Approvals

Agency	Agency Approvals	File Number
US	UL 1449 4th & cUL	VZCA2.E515006 VZCA8.E515006



Features :

- RoHS compliant
- Halogen-free series are available
- Body size: $\Phi 05 \sim \Phi 20\text{mm}$



Applications :

- Power supply
- Home appliance
- Industrial equipment
- Telecommunication system
- Smart meter
- Lighting products
- Photovoltaic industry

Absolute Maximum Ratings

	V Series	Units
Steady State :		
AC Voltage Range (V_{AC})	130 to 680	V
DC Voltage Range (V_{DC})	170 to 895	V
Transients :		
Peak Current for 8/20 μ S Current Wave	800 to 10000	A
Energy Range For 10/1000 μ S Current Wave	17.5 to 620	J
Operation Ambient Temperature Range	-40 to +105	$^{\circ}\text{C}$
Storage Temperature Range	-40 to +125	$^{\circ}\text{C}$
Varistor Voltage Range $V_n(V_{DC})$	200 to 1100	V
Insulation Resistance	>1000	M Ω
Typical Response Time	<25	ns

FMOV05-V Series

Device Ratings and Characteristics												
Part Number	Maximum Continuous Voltage		Varistor Voltage (@1mA)			Maximum Clamping Voltage @Test Current (@8/20µs)		Maximum Energy (@10/1000µs)	Maximum Peak Current (@8/20µs)	Rated Power	Typical Capacitance (@1KHz)	Agency Approvals
	ACrms(V)	DC(V)	Vn(V _{DC})	Min.	Max.	Vc(V)	I _p (A)	(J)	(A)	(W)	(pF)	
FMOV05201-V	130	170	200	180	220	355	5	17.5	800	0.25	70	
FMOV05221-V	140	180	220	198	242	380	5	19	800	0.25	60	
FMOV05241-V	150	200	240	216	264	415	5	21	800	0.25	60	
FMOV05271-V	175	225	270	243	297	475	5	24	800	0.25	50	
FMOV05301-V	195	250	300	270	330	505	5	26	800	0.25	50	
FMOV05331-V	215	275	330	297	363	585	5	28	800	0.25	45	
FMOV05361-V	230	300	360	324	396	620	5	32	800	0.25	40	
FMOV05391-V	250	320	390	351	429	675	5	35	800	0.25	40	
FMOV05431-V	275	350	430	387	473	745	5	40	800	0.25	35	
FMOV05471-V	300	385	470	423	517	810	5	42	800	0.25	30	
FMOV05511-V	320	410	510	459	561	878	5	45	800	0.25	30	
FMOV05561-V	350	460	560	504	616	940	5	45	800	0.25	30	
FMOV05621-V	395	510	620	558	682	1050	5	45	800	0.25	26	
FMOV05681-V	420	560	680	612	748	1120	5	48	800	0.25	20	
FMOV05751-V	465	615	750	675	825	1240	5	48	800	0.25	20	

FMOV07-V Series

Device Ratings and Characteristics												
Part Number	Maximum Continuous Voltage		Varistor Voltage (@1mA)			Maximum Clamping Voltage @Test Current (@8/20µs)		Maximum Energy (@10/1000µs)	Maximum Peak Current (@8/20µs)	Rated Power	Typical Capacitance (@1KHz)	Agency Approvals
	ACrms(V)	DC(V)	Vn(Vdc)	Min.	Max.	Vc(V)	Ip(A)	(J)	(A)	(W)	(pF)	
FMOV07201-V	130	170	200	180	220	355	10	17.5	1800	0.25	200	
FMOV07221-V	140	180	220	198	242	380	10	19	1800	0.25	190	
FMOV07241-V	150	200	240	216	264	415	10	21	1800	0.25	170	
FMOV07271-V	175	225	270	243	297	475	10	24	1800	0.25	150	
FMOV07301-V	195	250	300	270	330	505	10	26	1800	0.25	140	
FMOV07331-V	215	275	330	297	363	585	10	28	1800	0.25	130	
FMOV07361-V	230	300	360	324	396	620	10	32	1800	0.25	130	
FMOV07391-V	250	320	390	351	429	675	10	35	1800	0.25	130	
FMOV07431-V	275	350	430	387	473	745	10	40	1800	0.25	120	
FMOV07471-V	300	385	470	423	517	810	10	42	1800	0.25	100	
FMOV07511-V	320	410	510	459	561	878	10	45	1800	0.25	90	
FMOV07561-V	350	460	560	504	616	940	10	45	1800	0.25	90	
FMOV07621-V	395	510	620	558	682	1050	10	45	1800	0.25	90	
FMOV07681-V	420	560	680	612	748	1120	10	48	1800	0.25	80	
FMOV07751-V	465	615	750	675	825	1240	10	48	1800	0.25	80	
FMOV07781-V	485	640	780	702	858	1290	10	50	1800	0.25	80	
FMOV07821-V	510	670	820	738	902	1355	10	50	1800	0.25	70	

FMOV10-V Series

Device Ratings and Characteristics												
Part Number	Maximum Continuous Voltage		Varistor Voltage (@1mA)			Maximum Clamping Voltage @Test Current (@8/20µs)		Maximum Energy (@10/1000µs)	Maximum Peak Current (@8/20µs)	Rated Power	Typical Capacitance (@1KHz)	Agency Approvals
	ACrms(V)	DC(V)	Vn(V _{DC})	Min.	Max.	Vc(V)	I _p (A)	(J)	(A)	(W)	(pF)	
FMOV10201-V	130	170	200	180	220	340	25	35	3500	0.4	430	
FMOV10221-V	140	180	220	198	242	360	25	39	3500	0.4	410	
FMOV10241-V	150	200	240	216	264	395	25	42	3500	0.4	380	
FMOV10271-V	175	225	270	243	297	455	25	49	3500	0.4	350	
FMOV10301-V	195	250	300	270	330	500	25	55	3500	0.4	330	
FMOV10331-V	215	275	330	297	363	550	25	58	3500	0.4	300	
FMOV10361-V	230	300	360	324	396	595	25	65	3500	0.4	300	
FMOV10391-V	250	320	390	351	429	650	25	70	3500	0.4	300	
FMOV10431-V	275	350	430	387	473	710	25	80	3500	0.4	270	
FMOV10471-V	300	385	470	423	517	775	25	85	3500	0.4	230	
FMOV10511-V	320	410	510	459	561	845	25	92	3500	0.4	210	
FMOV10561-V	350	460	560	504	616	915	25	92	3500	0.4	200	
FMOV10621-V	395	510	620	558	682	1020	25	95	3500	0.4	180	
FMOV10681-V	420	560	680	612	748	1120	25	98	3500	0.4	150	
FMOV10751-V	465	615	750	675	825	1235	25	100	3500	0.4	140	
FMOV10781-V	485	640	780	702	858	1290	25	100	3500	0.4	140	
FMOV10821-V	510	670	820	738	902	1355	25	110	3500	0.4	140	
FMOV10911-V	550	745	910	819	1001	1500	25	130	3500	0.4	130	
FMOV10102-V	625	825	1000	900	1100	1650	25	140	3500	0.4	130	
FMOV10112-V	680	895	1100	990	1210	1815	25	155	3500	0.4	120	

FMOV14-V Series

Device Ratings and Characteristics												
Part Number	Maximum Continuous Voltage		Varistor Voltage (@1mA)			Maximum Clamping Voltage @Test Current (@8/20µs)		Maximum Energy (@10/1000µs)	Maximum Peak Current (@8/20µs)	Rated Power	Typical Capacitance (@1KHz)	Agency Approvals
	ACrms(V)	DC(V)	Vn(Vbc)	Min.	Max.	Vc(V)	Ip(A)	(J)	(A)	(W)	(pF)	
FMOV14201-V	130	170	200	180	220	340	50	84	6000	0.6	770	
FMOV14221-V	140	180	220	198	242	360	50	91	6000	0.6	740	
FMOV14241-V	150	200	240	216	264	395	50	98	6000	0.6	700	
FMOV14271-V	175	225	270	243	297	455	50	112	6000	0.6	640	
FMOV14301-V	195	250	300	270	330	500	50	123	6000	0.6	400	
FMOV14331-V	215	275	330	297	363	550	50	133	6000	0.6	580	
FMOV14361-V	230	300	360	324	396	595	50	147	6000	0.6	540	
FMOV14391-V	250	320	390	351	429	650	50	161	6000	0.6	500	
FMOV14431-V	275	350	430	387	473	710	50	182	6000	0.6	450	
FMOV14471-V	300	385	470	423	517	775	50	196	6000	0.6	400	
FMOV14511-V	320	410	510	459	561	845	50	210	6000	0.6	350	
FMOV14561-V	350	460	560	504	616	915	50	231	6000	0.6	350	
FMOV14621-V	395	510	620	558	682	1020	50	252	6000	0.6	330	
FMOV14681-V	420	560	680	612	748	1120	50	266	6000	0.6	310	
FMOV14751-V	465	615	750	675	825	1235	50	280	6000	0.6	300	
FMOV14781-V	485	640	780	702	858	1290	50	280	6000	0.6	300	
FMOV14821-V	510	670	820	738	902	1355	50	280	6000	0.6	270	
FMOV14911-V	550	745	910	819	1001	1500	50	308	6000	0.6	260	
FMOV14102-V	625	825	1000	900	1100	1650	50	336	6000	0.6	250	
FMOV14112-V	680	895	1100	990	1210	1815	50	364	6000	0.6	240	

FMOV20-V Series

Device Ratings and Characteristics												
Part Number	Maximum Continuous Voltage		Varistor Voltage (@1mA)			Maximum Clamping Voltage @Test Current (@8/20μs)		Maximum Energy (@10/1000μs)	Maximum Peak Current (@8/20μs)	Rated Power	Typical Capacitance (@1KHz)	Agency Approvals
	ACrms(V)	DC(V)	Vn(V _{DC})	Min.	Max.	Vc(V)	I _p (A)	(J)	(A)	(W)	(pF)	
FMOV20201-V	130	170	200	180	220	340	100	140	10000	1	1700	
FMOV20221-V	140	180	220	198	242	360	100	155	10000	1	1600	
FMOV20241-V	150	200	240	216	264	395	100	170	10000	1	1500	
FMOV20271-V	175	225	270	243	297	455	100	190	10000	1	1300	
FMOV20301-V	195	250	300	270	330	500	100	215	10000	1	1200	
FMOV20331-V	215	275	330	297	363	550	100	228	10000	1	1100	
FMOV20361-V	230	300	360	324	396	595	100	255	10000	1	1100	
FMOV20391-V	250	320	390	351	429	650	100	275	10000	1	1100	
FMOV20431-V	275	350	430	387	473	710	100	303	10000	1	1000	
FMOV20471-V	300	385	470	423	517	775	100	350	10000	1	900	
FMOV20511-V	320	410	510	459	561	845	100	382	10000	1	800	
FMOV20561-V	350	460	560	504	616	915	100	382	10000	1	750	
FMOV20621-V	395	510	620	558	682	1020	100	400	10000	1	570	
FMOV20681-V	420	560	680	612	748	1120	100	420	10000	1	550	
FMOV20751-V	465	615	750	675	825	1235	100	420	10000	1	530	
FMOV20781-V	485	640	780	702	858	1290	100	440	10000	1	500	
FMOV20821-V	510	670	820	738	902	1355	100	460	10000	1	500	
FMOV20911-V	550	745	910	819	1001	1500	100	510	10000	1	480	
FMOV20102-V	625	825	1000	900	1100	1650	100	565	10000	1	460	
FMOV20112-V	680	895	1100	990	1210	1815	100	620	10000	1	400	

Transient V-I Characteristic Curves

FMOV05201-V to FMOV05751-V

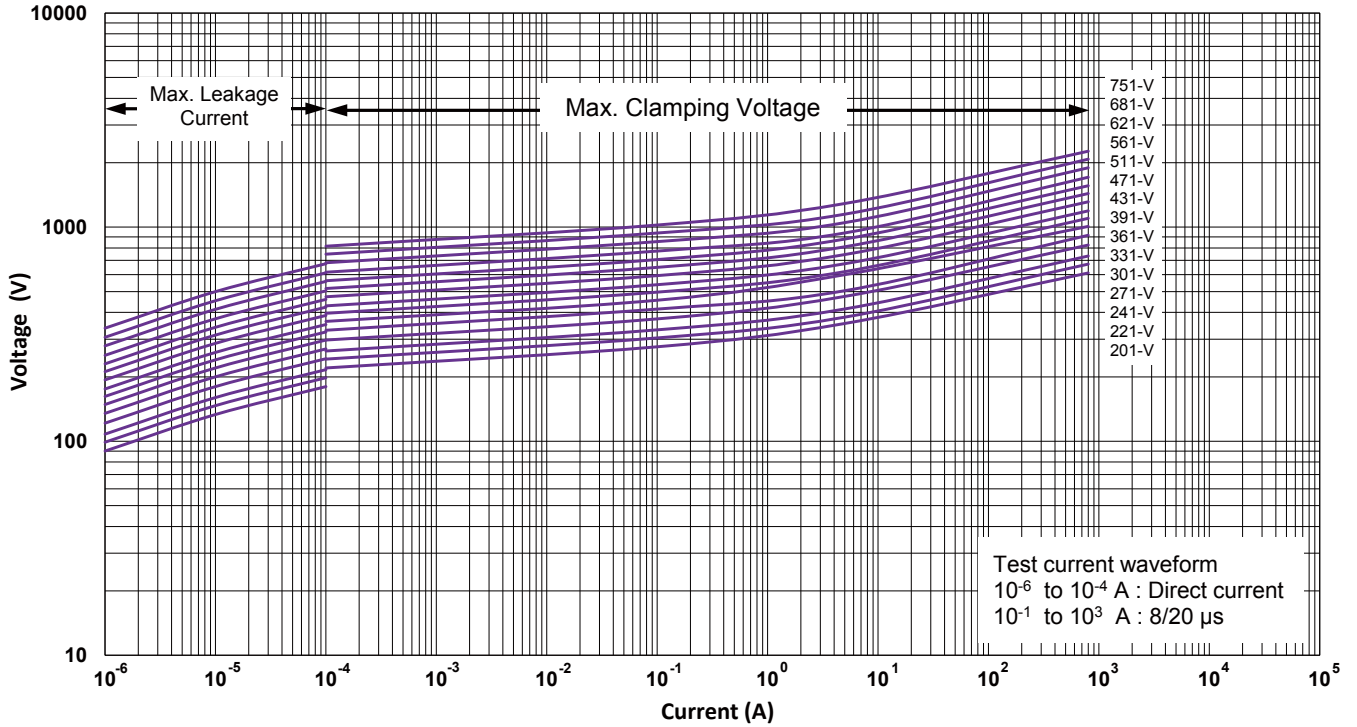

FMOV07201-V to FMOV07471-V

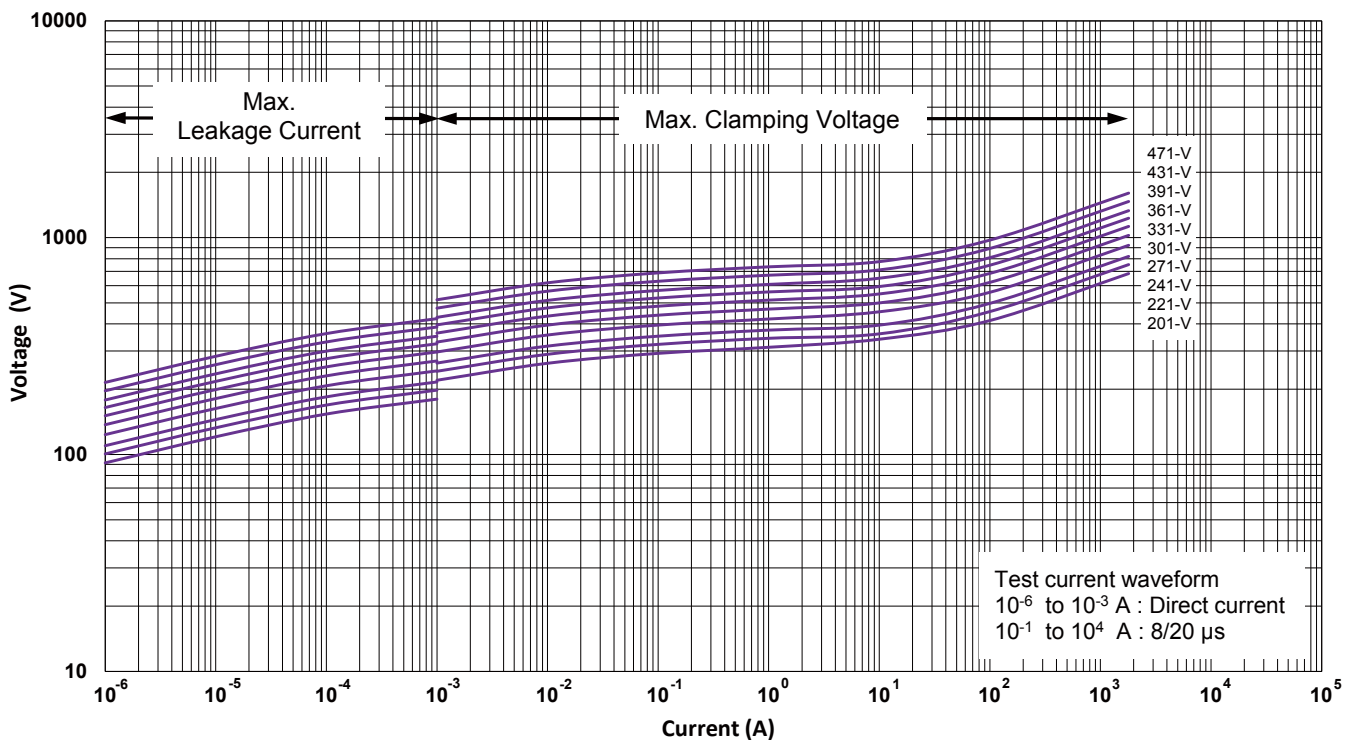

Transient V-I Characteristic Curves

FMOV07511-V to FMOV07821-V

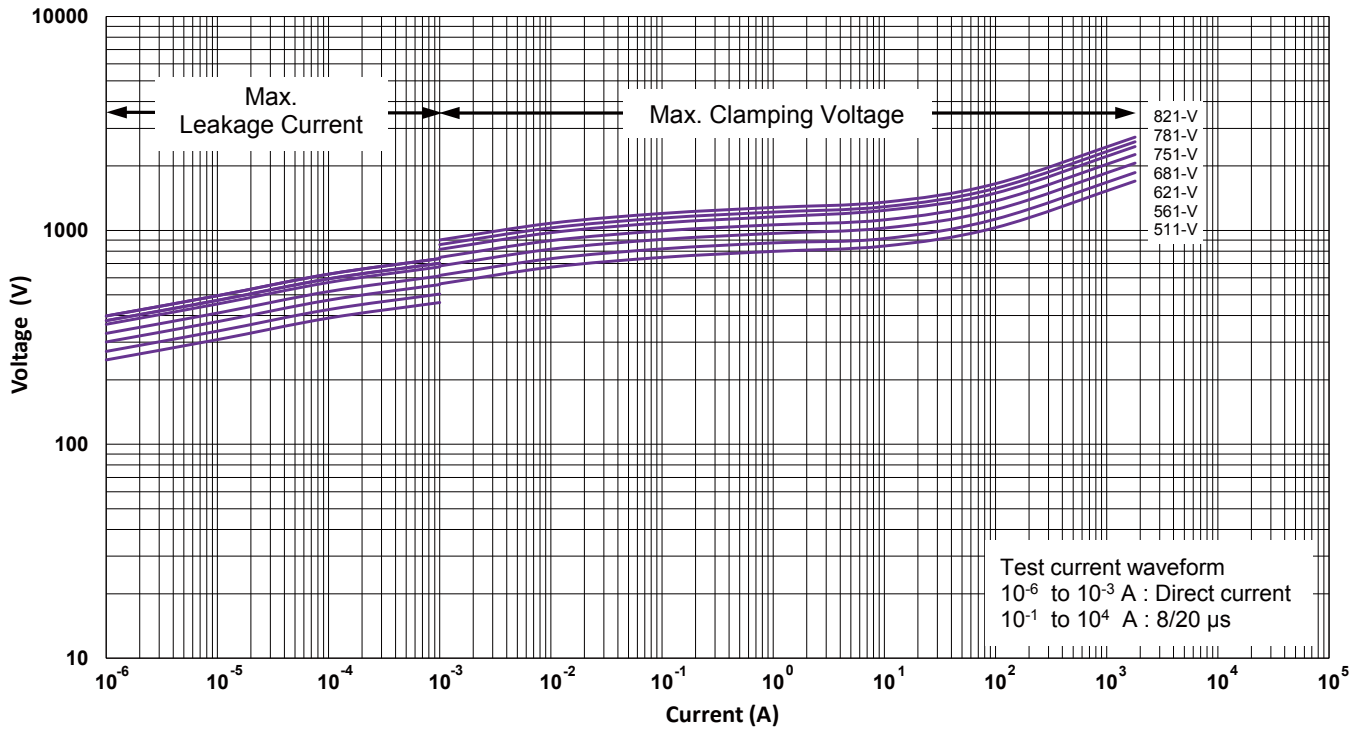

FMOV10201-V to FMOV10471-V

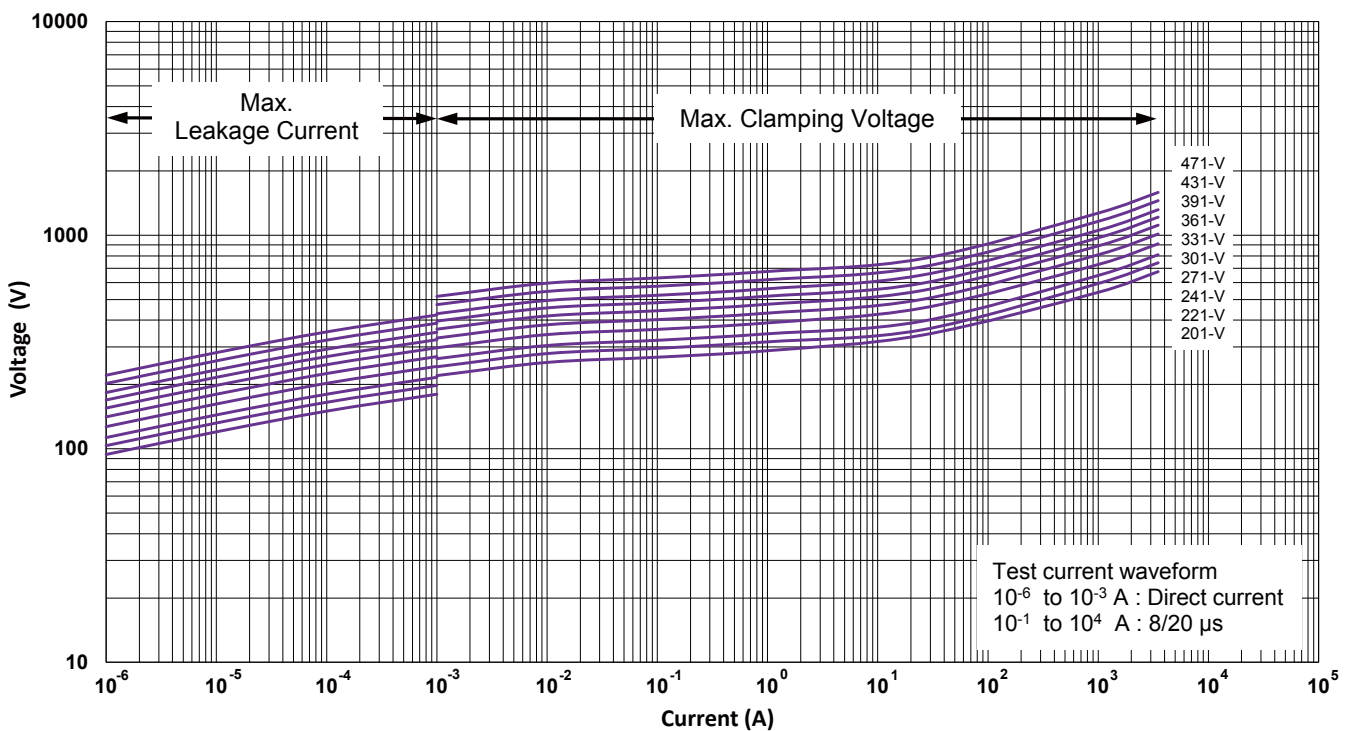

Transient V-I Characteristic Curves

FMOV10511-V to FMOV10112-V

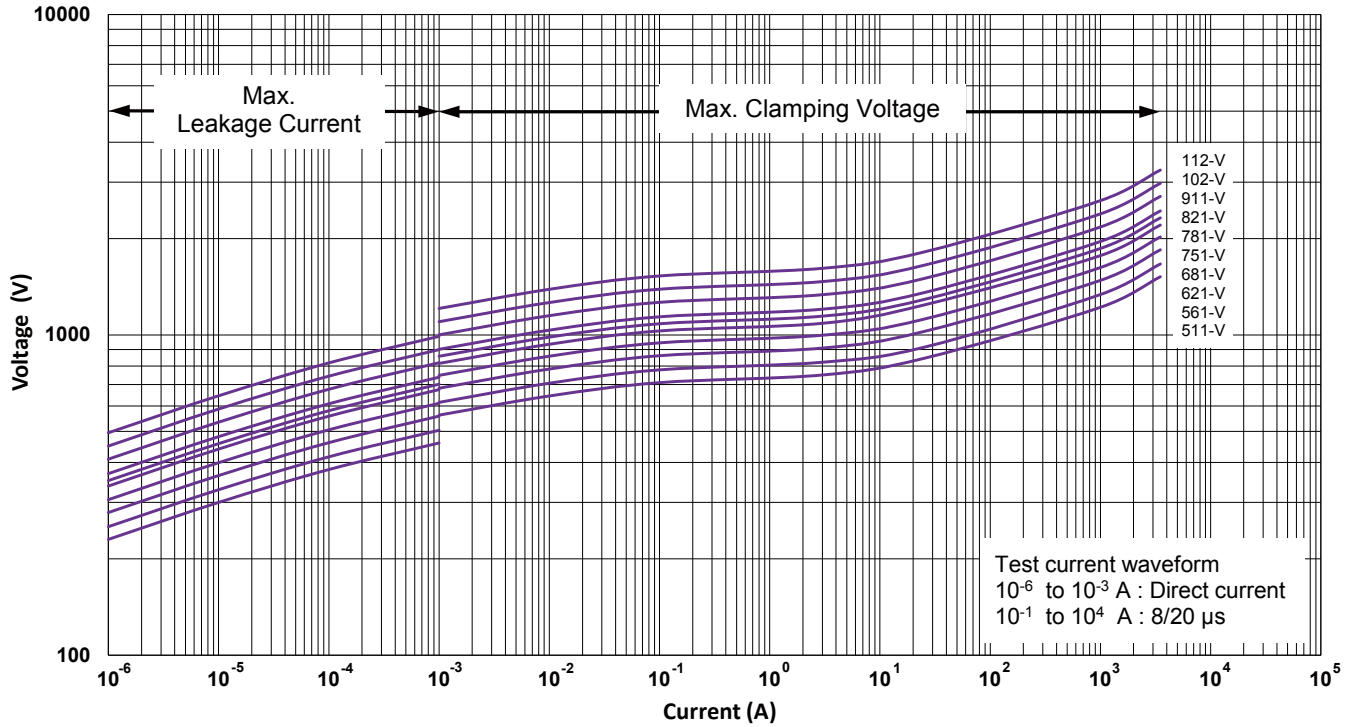

FMOV14201-V to FMOV14471-V

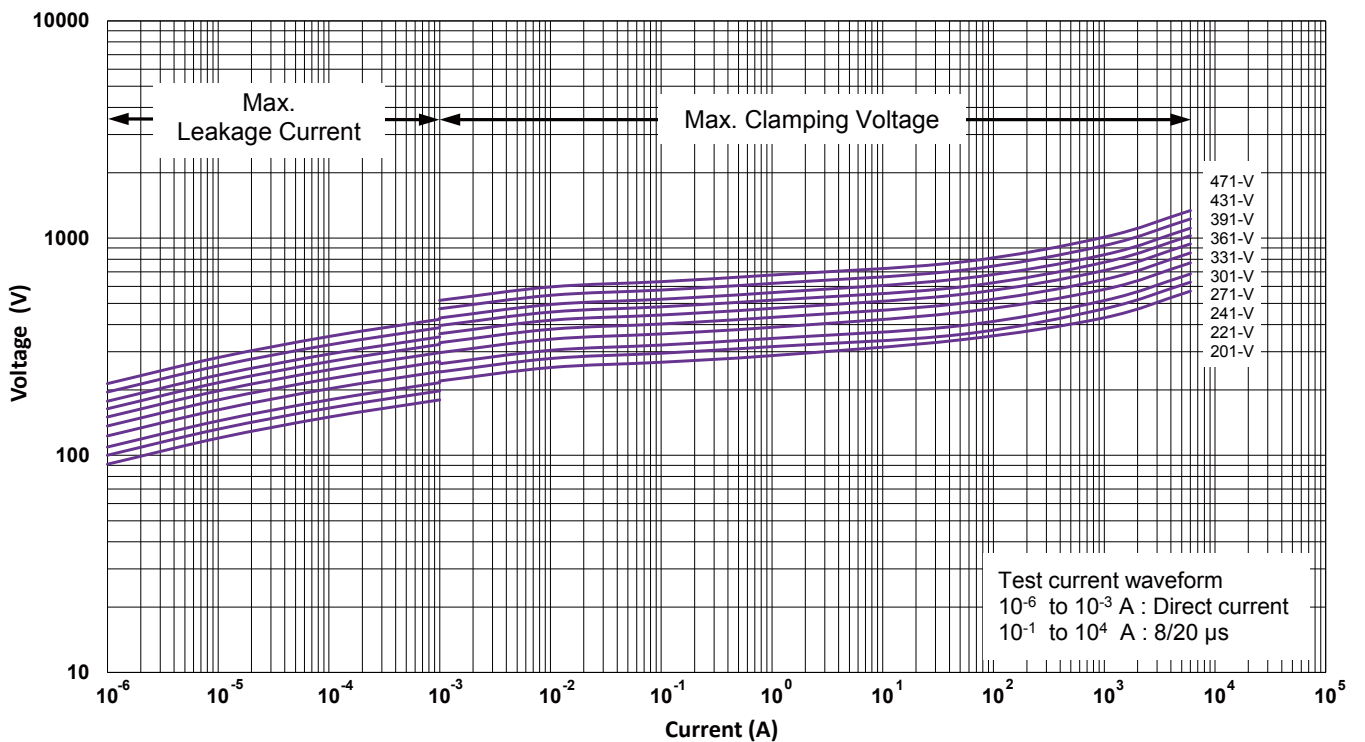

Transient V-I Characteristic Curves

FMOV14511-V to FMOV14112-V

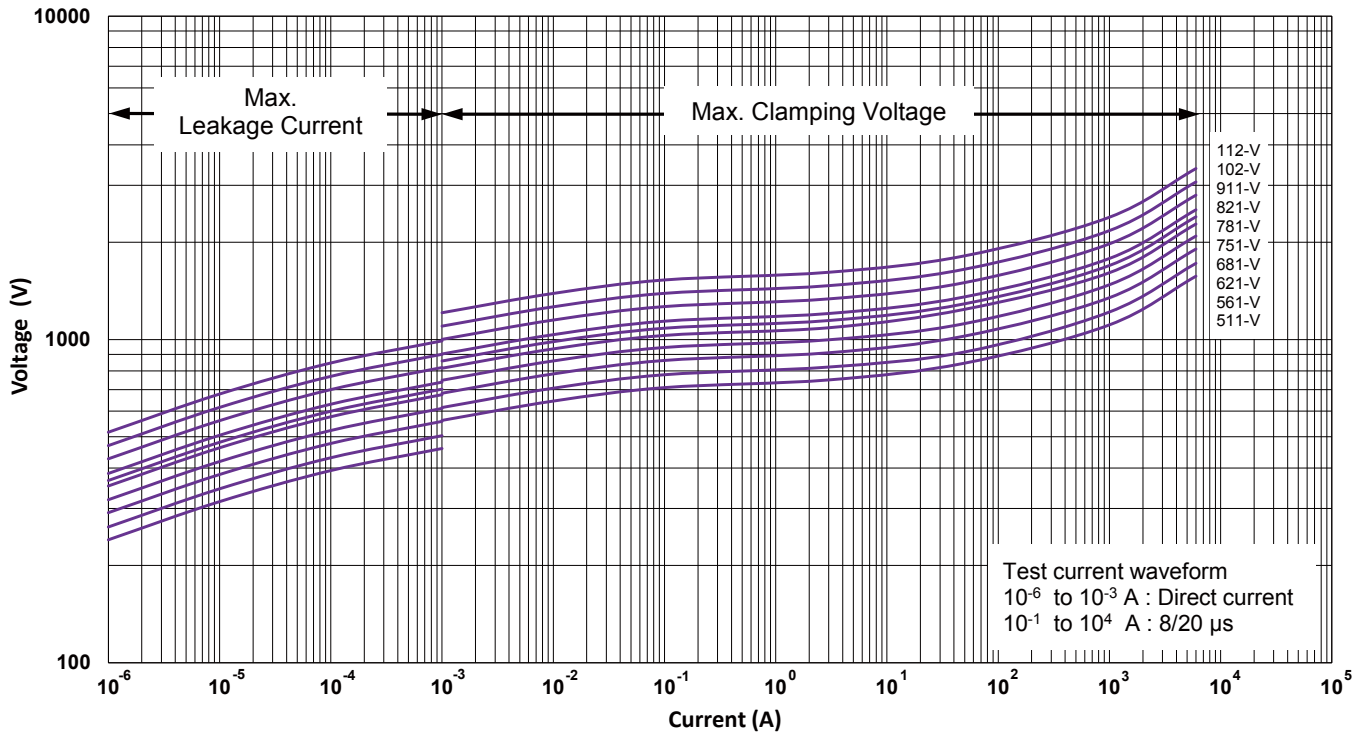

FMOV20201-V to FMOV20471-V

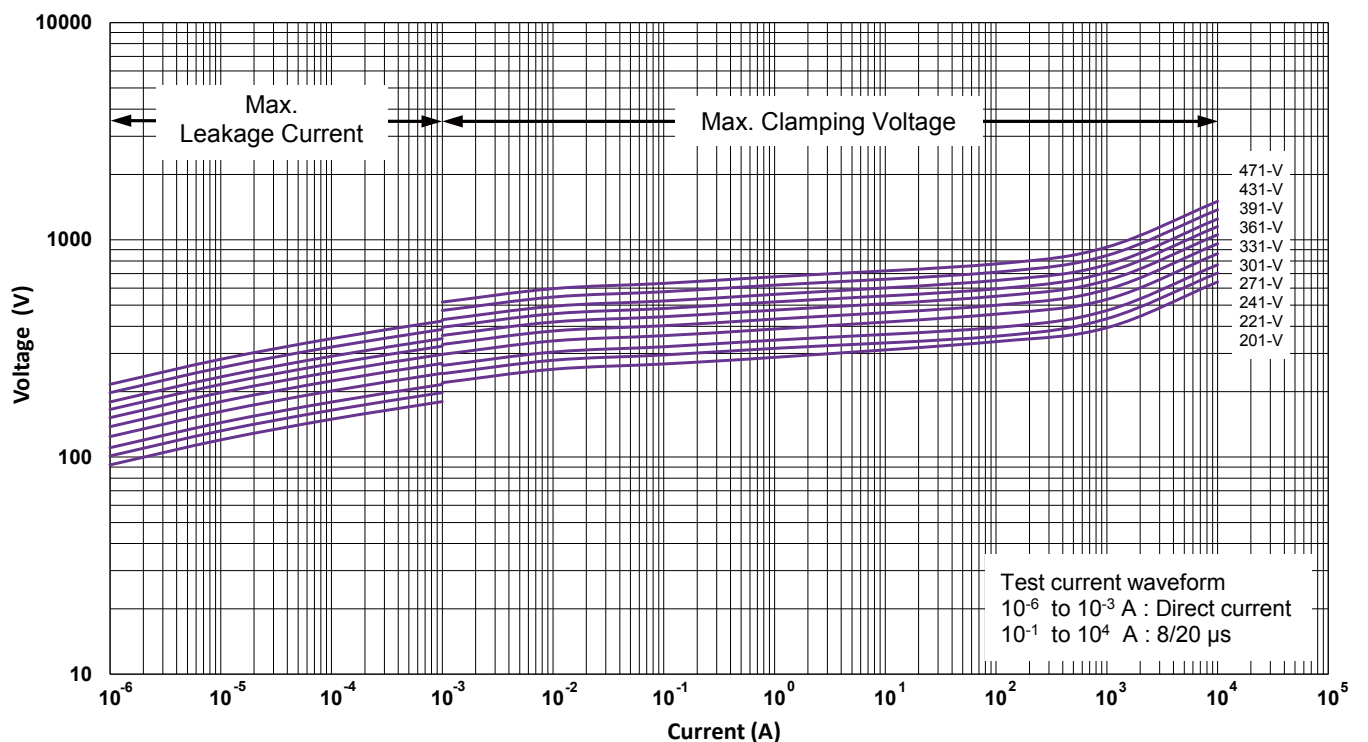

Transient V-I Characteristic Curves

FMOV20511-V to FMOV20112-V

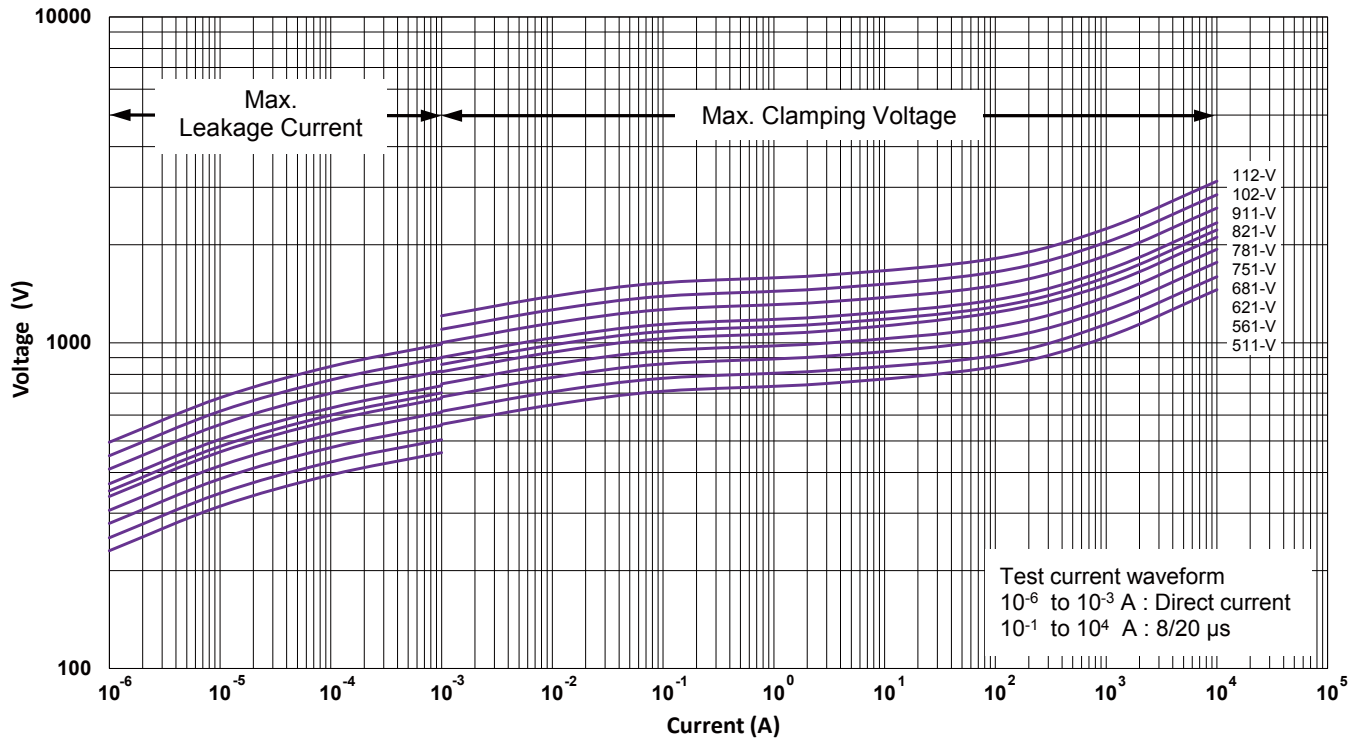

Impulse Life Time Rating Curves

FMOV05201-V to FMOV05751-V

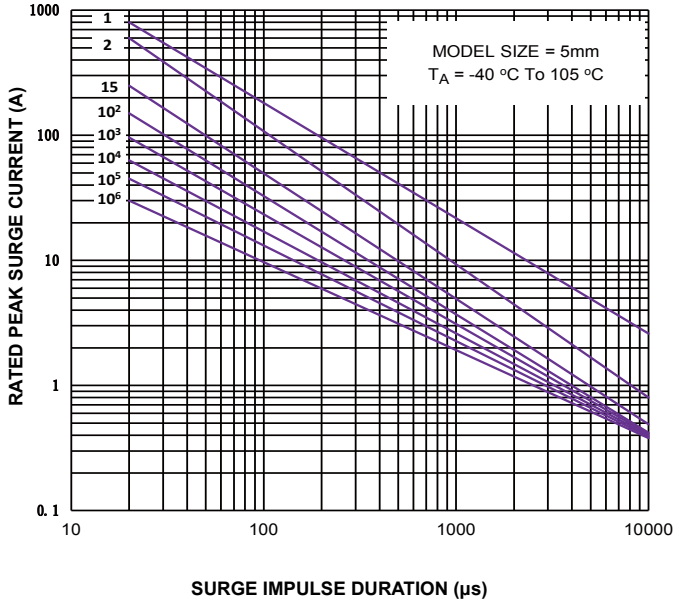

FMOV07201-V to FMOV07821-V

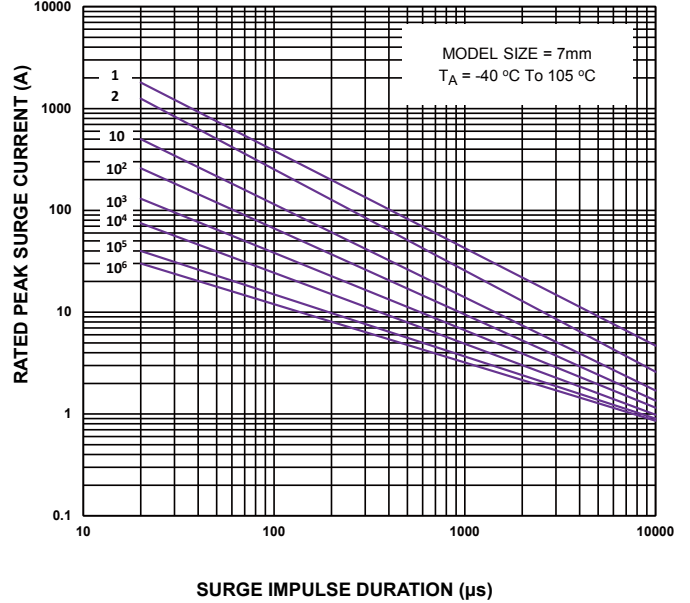

FMOV10201-V to FMOV101121-V

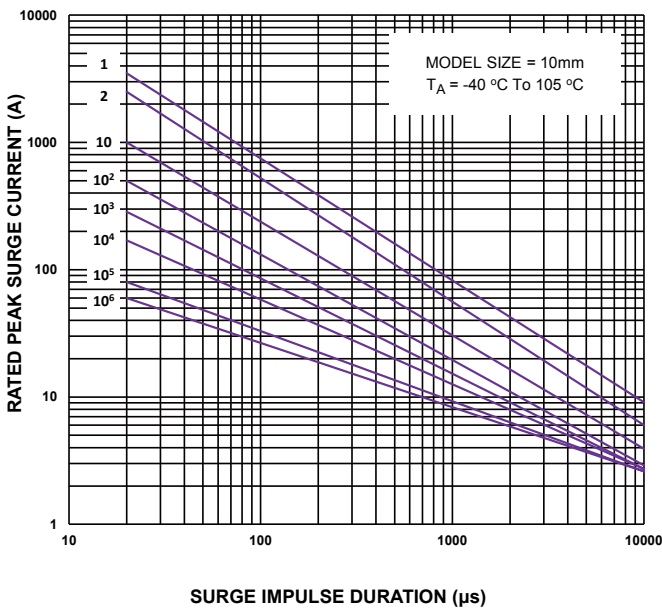

FMOV14201-V to FMOV14112-V

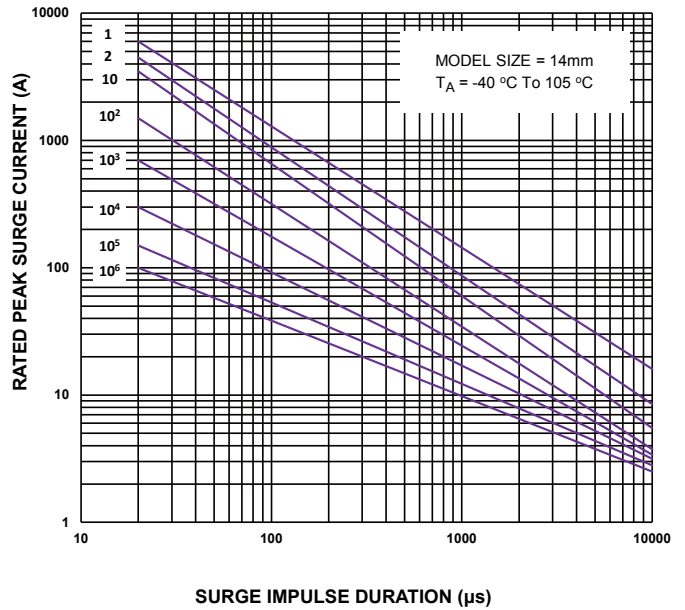

Impulse Life Time Rating Curves

FMOV20201-V to FMOV20112-V

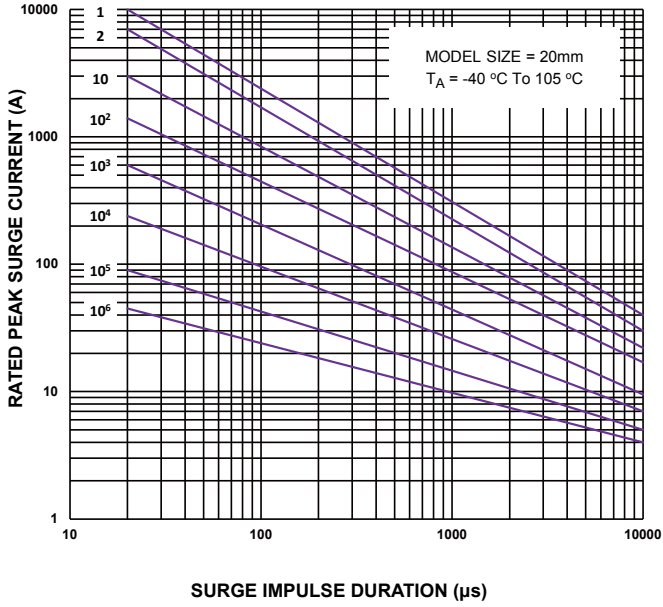

Power Derating Curve

Should transients occur in rapid succession, the average power dissipation is the energy (watt-seconds) per pulse times the number of pulses per second. The power so developed must be with the specifications shown on the Device Ratings and Specifications Table for the specific device. The operating values of a MOV need to be derated at high temperatures as shown above. Because varistors only dissipate a relatively small amount of average power they are not suitable for repetitive applications that involve substantial amounts of average power dissipation.

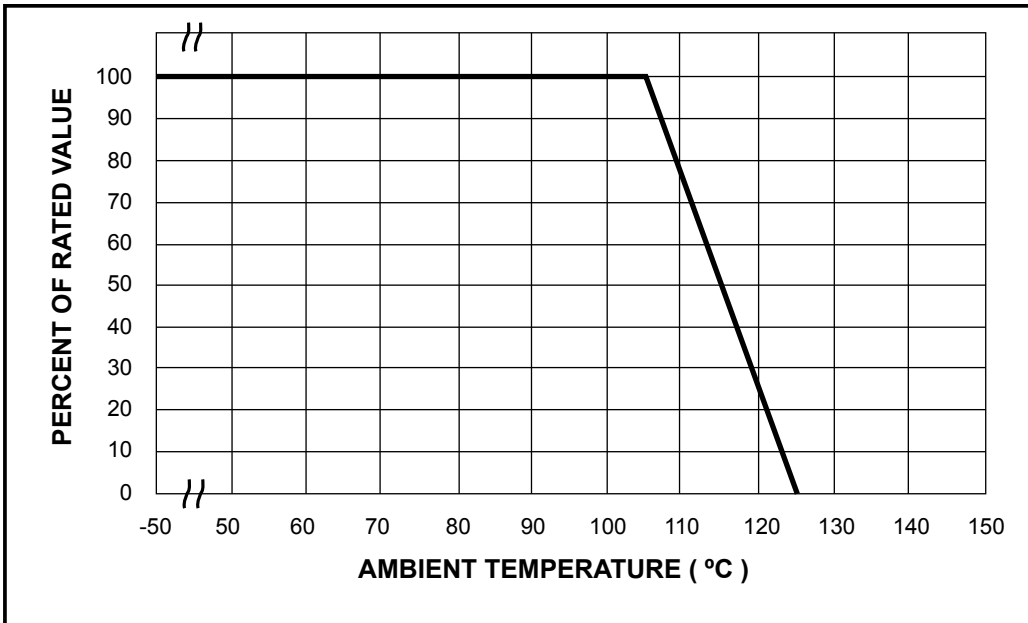

Surge Current Standard Waveform

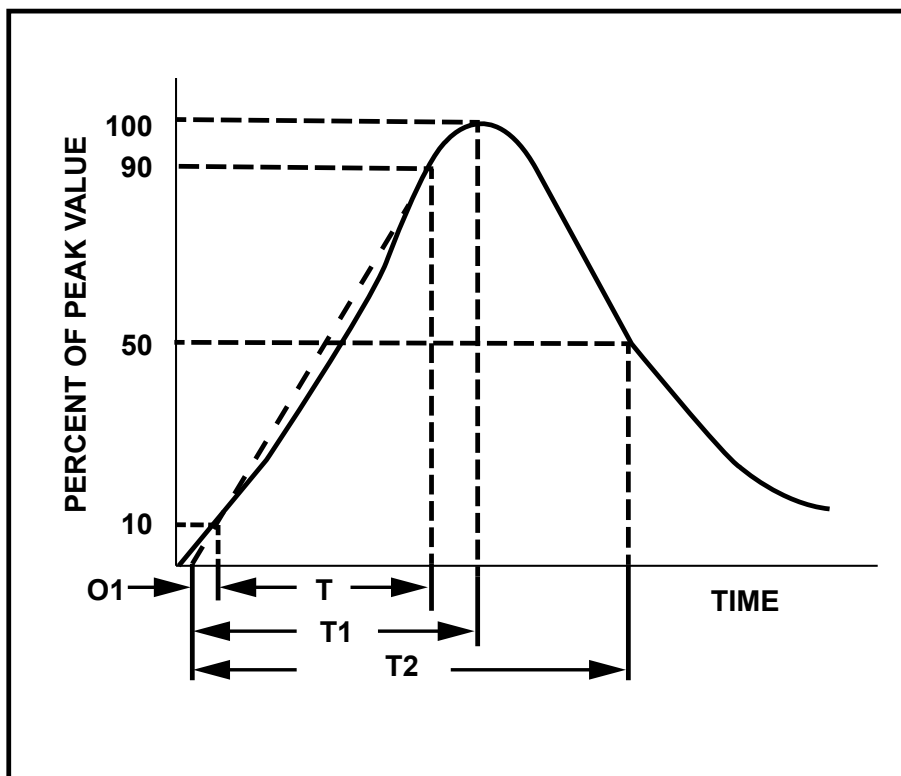

O1 = Virtual Origin of Wave
 T = Time from 10% to 90% of Peak
 $T1 = \text{Rise Time} = 1.25 \times T$
 $T2 = \text{Decay Time}$
 Example - For an 8/20 μs Current Waveform :
 $8\mu\text{s} = T1 = \text{Rise Time}$
 $20\mu\text{s} = T2 = \text{Decay Time}$

Product Dimensions

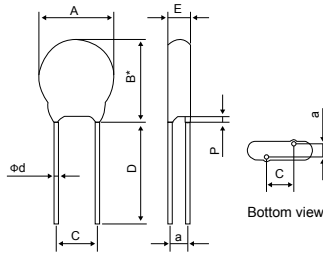

Fig 1. Straight Lead

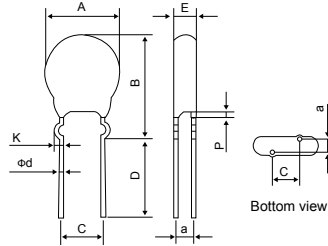

Fig 2. Outside Kink Lead

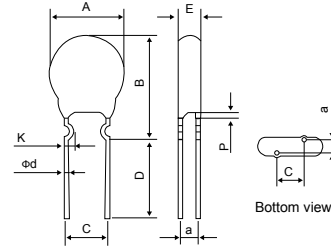

Fig 3. Inside Kink Lead

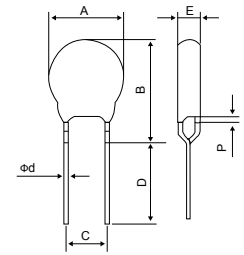

Fig 4. In Line Kink Lead

Dimension Table

Unit : mm

Model size Symbol	05V		07V		10V		14V		20V		
	Min.	Max.	Min.	Max.	Min.	Max.	Min.	Max.	Min.	Max.	
A	5.5	7.5	7.5	9.0	10.5	14.0	13.5	17.5	19.5	25.0	
B(Max.)	180-V ~ 271-V	-	13.0	-	15.0	-	19.5	-	22.5	-	30.0
	>271-V	-	13.0	-	15.0	-	20.5	-	23.5	-	31.0
B*(Max.)	-	10.0	-	12.0	-	17	-	20.5	-	28.0	
C(±1.0)	5.0		5.0		7.5		7.5		10.0		
D(Typ.)	25.0		25.0		25.0		25.0		25.0		
P(Max.)	-	3.0	-	3.0	-	3.0	-	3.0	-	3.0	
K	0.8	1.6	0.8	1.6	0.8	1.6	0.8	1.6	0.8	1.6	
Φd(±0.05)	0.60		0.6		0.8		0.8		1.0		
E	E Max. Table										

E Max. Table

Unit : mm

Model	05V	07V	10V	14D	20V	a (±1.0)	Model	05V	07V	10V	14V	20V	a (±1.0)
201-V	3.3	3.5	3.9	4.0	4.3	1.5	511-V	4.8	5.0	5.3	5.4	5.7	2.6
221-V	3.4	3.6	4.0	4.1	4.4	1.6	561-V	5.0	5.2	5.5	5.6	5.9	2.8
241-V	3.5	3.7	4.1	4.2	4.5	1.7	621-V	5.3	5.5	5.7	5.8	6.1	3.1
271-V	3.7	3.9	4.2	4.3	4.6	1.8	681-V	5.4	5.6	5.8	5.9	6.2	3.3
301-V	3.9	4.1	4.3	4.4	4.7	1.9	751-V	5.6	5.8	6.0	6.1	6.4	3.6
331-V	4.0	4.2	4.5	4.6	4.9	2.0	781-V	-	6.0	6.3	6.4	6.7	3.8
361-V	4.1	4.3	4.7	4.8	5.1	2.1	821-V	-	6.3	6.5	6.6	6.9	4.0
391-V	4.2	4.4	4.8	4.9	5.2	2.3	911-V	-	-	6.6	6.7	7.0	4.3
431-V	4.4	4.6	5.0	5.1	5.4	2.4	102-V	-	-	7.0	7.1	7.4	4.6
471-V	4.6	4.8	5.2	5.3	5.6	2.5	112-V	-	-	7.4	7.5	7.9	5.2

Part Numbering and Marking System

Part Numbering System :

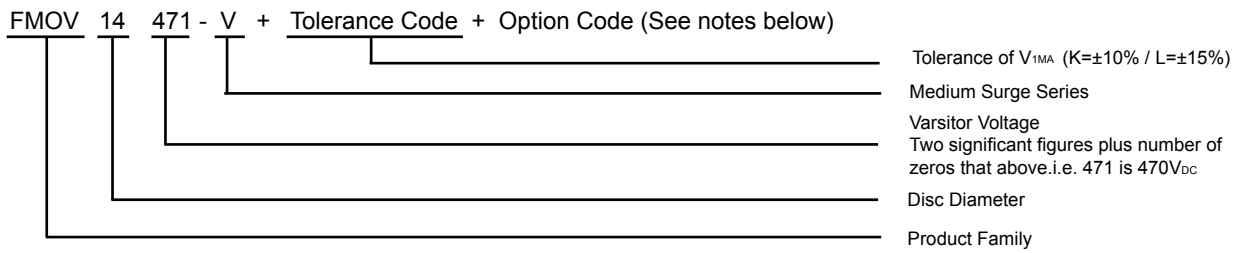

Marking System :

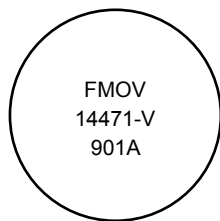

Example

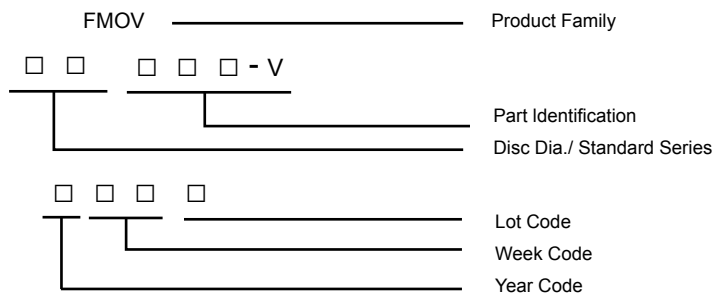

Order Notes

Main Part Code :

Part No + Tolerance Code + Packaging + Lead Type Designators + Option Code

Ordering examples :

Straight Lead Bulk Pack (Standard)	Straight Lead (Short Cut) Bulk Pack	Straight Lead Tape & Reel Pack	Straight Lead Flat Box Pack
FMOV05471-VKBS	FMOV05471-VKBSXXX	FMOV05471-VKTS	FMOV05471-VKAS
FMOV07471-VKBS	FMOV07471-VKBSXXX	FMOV07471-VKTS	FMOV07471-VKAS
FMOV10471-VKBS	FMOV10471-VKBSXXX	FMOV10471-VKTS	FMOV10471-VKAS
FMOV14471-VKBS	FMOV14471-VKBSXXX	FMOV14471-VKTS	FMOV14471-VKAS
FMOV20471-VKBS	FMOV20471-VKBSXXX	-	-

Outside Kink Lead Bulk Pack	Outside Kink lead (Short Cut) Bulk Pack	Outside Kink Lead Tape & Reel Pack	Outside Kink Lead Flat Box Pack
FMOV05471-VKBO	FMOV05471-VKBOXXX	FMOV05471-VKTO	FMOV05471-VKAO
FMOV07471-VKBO	FMOV07471-VKBOXXX	FMOV07471-VKTO	FMOV07471-VKAO
FMOV10471-VKBO	FMOV10471-VKBOXXX	FMOV10471-VKTO	FMOV10471-VKAO
FMOV14471-VKBO	FMOV14471-VKBOXXX	FMOV14471-VKTO	FMOV14471-VKAO
FMOV20471-VKBO	FMOV20471-VKBOXXX	-	-

Inside Kink lead Bulk Pack	Inside Kink Lead (Short Cut) Bulk Pack	Inside Kink Lead Tape & Reel Pack	Inside Kink Lead Flat Box Pack
FMOV05471-VKBK	FMOV05471-VKBKXXX	FMOV05471-VKTK	FMOV05471-VKAK
FMOV07471-VKBK	FMOV07471-VKBKXXX	FMOV07471-VKTK	FMOV07471-VKAK
FMOV10471-VKBK	FMOV10471-VKBKXXX	FMOV10471-VKTK	FMOV10471-VKAK
FMOV14471-VKBK	FMOV14471-VKBKXXX	FMOV14471-VKTK	FMOV14471-VKAK
FMOV20471-VKBK	FMOV20471-VKBKXXX	-	-

In Line Kink Lead Bulk Pack	In Line Kink Lead (Short Cut) Bulk Pack	In Line Kink Lead Tape & Reel Pack	In Line Kink Lead Flat Box Pack
FMOV05471-VKBI	FMOV05471-VKBIXXX	FMOV05471-VKTI	FMOV05471-VKAI
FMOV07471-VKBI	FMOV07471-VKBIXXX	FMOV07471-VKTI	FMOV07471-VKAI
FMOV10471-VKBI	FMOV10471-VKBIXXX	FMOV10471-VKTI	FMOV10471-VKAI
FMOV14471-VKBI	FMOV14471-VKBIXXX	FMOV14471-VKTI	FMOV14471-VKAI
FMOV20471-VKBI	FMOV20471-VKBIXXX	-	-

Tape & Reel Pack Feed Hole Pitch
FMOV05471-VKTSA
FMOV05471-VKTSB
FMOV07471-VKTSA
FMOV07471-VKTSB
FMOV10471-VKTSA
FMOV10471-VKTSB
FMOV14471-VKTSA
FMOV14471-VKTSA

A : P0 → 12.7mm±0.2mm
B : P0 → 15.0mm±0.2mm

Tape and Reel Specifications

Radial devices on tape are supplied with straight leads or inline kink leads

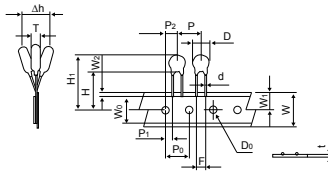

Figure: A

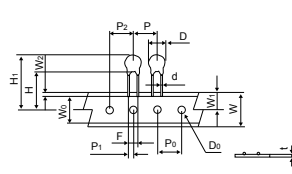

Figure: B

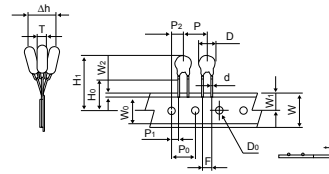

Figure: C

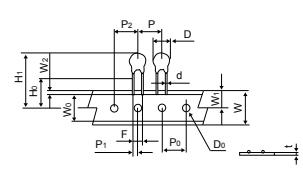

Figure: D

Straight Leads

Inline Kink Leads

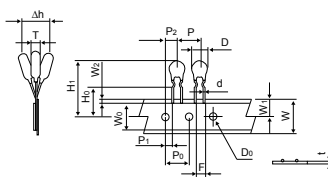

Figure: E

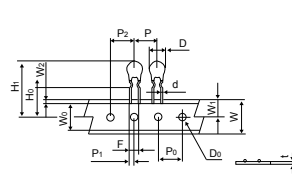

Figure: F

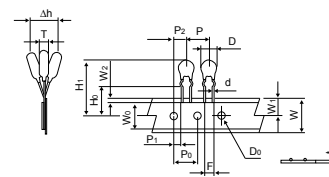

Figure: G

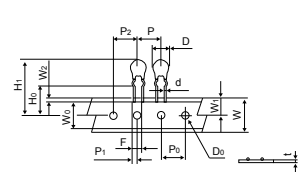

Figure: H

Inside Kink Leads

Outside Kink Leads

Symbol	Parameter	Model					
		05V	07V	10V	15V	25V	30V
P	Pitch of Component	12.7±1.0	12.7±1.0	12.7±1.0	15.0±1.0	25.4±1.0	30.0±1.0
P0	Feed Hole Pitch	12.7±0.2	12.7±0.2	12.7±0.2	15.0±0.2	12.7±0.2	15.0±0.2
P1	Feed Hole Center Lead	3.85±0.7	3.85±0.7	3.85±0.7	3.75±0.7	8.95±0.7	3.75±0.7
P2	Hole center to Component Center	6.35±0.7	6.35±0.7	6.35±0.7	7.5±0.7	12.7±0.7	7.5±0.7
F	Lead to Lead Distance	5.0±0.8	5.0±0.8	7.5±0.8	7.5±0.8	7.5±0.8	7.5±0.8
Δh	Component Alignment	2.0 Max	2.0 Max	2.0 Max	2.0 Max	2.0 Max	2.0 Max
W	Tape Width	18.0+1.0	18.0+1.0	18.0+1.0	18.0+1.0	18.0+1.0	18.0+1.0
		18.0-0.5	18.0-0.5	18.0-0.5	18.0-0.5	18.0-0.5	18.0-0.5
W0	Hold Down Tape Width	5.0 Min	5.0 Min	5.0 Min	5.0 Min	5.0 Min	5.0 Min
W1	Hole Position	9.0+0.75	9.0+0.75	9.0+0.75	9.0+0.75	9.0+0.75	9.0+0.75
		9.0-0.50	9.0-0.50	9.0-0.50	9.0-0.50	9.0-0.50	9.0-0.50
W2	Hold Down Tape Position	3.0 Max	3.0 Max	3.0 Max	3.0 Max	3.0 Max	3.0 Max
H	Height from Tape Center to Component Base	18.0+2.0	18.0+2.0	18.0+2.0	18.0+2.0	18.0+2.0	18.0+2.0
		18.0-0.0	18.0-0.0	18.0-0.0	18.0-0.0	18.0-0.0	18.0-0.0
H0	Seating Plane Height	16.0±0.5	16.0±0.5	16.0±0.5	16.0±0.5	16.0±0.5	16.0±0.5
H1	Component Height	32.0 Max	32.0 Max	36.0 Max	36.0 Max	40.0 Max	40.0 Max
D0	Feed Hole Diameter	4.0±0.2	4.0±0.2	4.0±0.2	4.0±0.2	4.0±0.2	4.0±0.2
t	Total Tape Thickness	0.7±0.2	0.7±0.2	0.7±0.2	0.7±0.2	0.7±0.2	0.7±0.2
L	Length of Clipped Lead	11.0 Max	11.0 Max	11.0 Max	11.0 Max	11.0 Max	11.0 Max
Figure		ACEG	ACEG	BDFH	ACEG	BDFH	ACEG

Unit: mm

Packaging Specifications

Bulk Product Packing

Series	Straight Lead Type Quantity (pcs/bag)	Outside Kink Lead Type Quantity (pcs/bag)	Inside Kink Lead Type Quantity (pcs/bag)	In Line Kink Lead Type Quantity (pcs/bag)
FMOV05-V Series	1000	1000	1000	1000
FMOV07-V Series	1000	1000	1000	1000
FMOV10-V Series	500	500	500	500
FMOV14-V Series	500	500	500	500
FMOV20-V Series	250	250	250	250

Tape & Reel Product Packing

Series	A (mm)	Quantity (pcs/reel)
FMOV05(201~391)-V-T-	43	2000
FMOV05(431~751)-V-T-		1500
FMOV07(201~391)-V-T-		2000
FMOV07(431~821)-V-T-		1500
FMOV10(201~621)-V-T-		1000
FMOV10(681~112)-V-T-	56	800
FMOV14(201~391)-V-T-		800
FMOV14(431~621)-V-T-		700
FMOV14(681~112)-V-T-		600

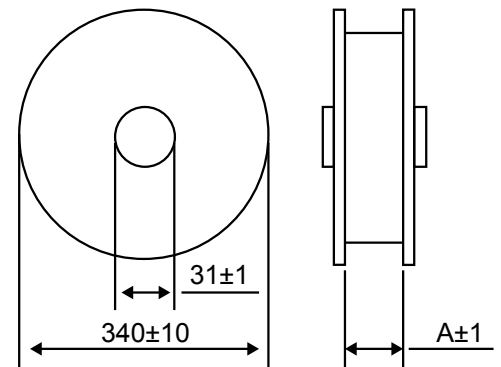

Box Product Packing

Series	Quantity (pcs/reel)
FMOV05(201~391)-V-A-	1000
FMOV05(431~751)-V-A-	800
FMOV07(201~391)-V-A-	1000
FMOV07(431~821)-V-A-	800
FMOV10(201~621)-V-A-	1000
FMOV10(681~112)-V-A-	800
FMOV14(201~621)-V-A-	500
FMOV14(681~112)-V-A-	400

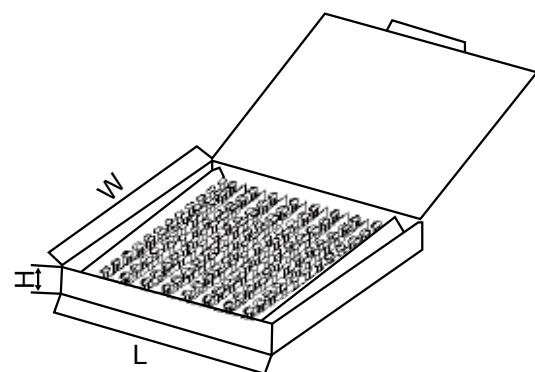

Series	L ± 5	W ± 5	H ± 5
FMOV05~07-V Series	340	245	45
FMOV10~14-V Series	340	245	50

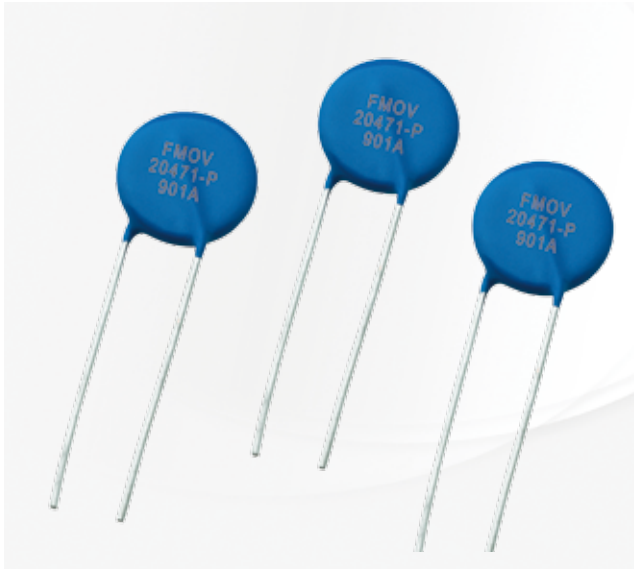

Description :

Fuzetec P Series MOV products are specially designed for applications requiring high surge energy absorption ratings and peak current capability. Available in 3 different sizes: 10mm/14mm/20mm, the high energy P series MOV offers higher surge suppression ability in compact packaging. MOV products have specific nonlinear and symmetrical V-I characteristics curve and unparalleled large peak current capability are used for absorption of transient voltage, suppression of pulse noise and circuit voltage stabilization.

Agency Approvals

Agency	Agency Approvals	File Number
US	UL 1449 4th & cUL	VZCA2.E515006 VZCA8.E515006
	IEC 61051-1:2007 IEC 61051-2:1991 IEC 61051-2:1991/AMD1:2009 IEC 61051-2-2:1991 *IEC 60950-1 Annex Q **IEC 62368-1:2018	40051896



SVHC Compliant



Features :

- RoHS compliant
- Halogen-free series are available
- Body size: $\Phi 10 \sim \Phi 20\text{mm}$
- FMOV10201-P~10112-P ;
FMOV14201-P~14112-P ;
FMOV20201-P~20112-P,
meet IEC 60950-1 Annex Q requirement.
**IEC 60950-1 will be replaced by IEC 62368-1 at the beginning of 2021.



Applications :

- Power supply
- Home appliance
- Industrial equipment
- Telecommunication system
- Smart meter
- Lighting products
- Photovoltaic industry



Absolute Maximum Ratings

	P Series	Units
Steady State:		
AC Voltage Range (V_{AC})	11 to 680	V
DC Voltage Range (V_{DC})	14 to 895	V
Transients:		
Peak Current for 8/20 μ S Current Wave	1500 to 15000	A
Energy Range For 10/1000 μ S Current Wave	4 to 720	J
Operation Ambient Temperature Range	-40 to +105	$^{\circ}\text{C}$
Storage Temperature Range	-40 to +125	$^{\circ}\text{C}$
Varistor Voltage Range $V_n(V_{DC})$	18 to 1100	V
Insulation Resistance	>1000	M Ω
Typical Response Time	<25	ns

FMOV10-P Series

Device Ratings and Characteristics												
Part Number	Maximum Continuous Voltage		Varistor Voltage (@1mA)			Maximum Clamping Voltage @Test Current (@8/20µs)		Maximum Energy (@10/1000µs)	Maximum Peak Current (@8/20µs)	Rated Power	Typical Capacitance (@1KHz)	Agency Approval
	ACrms(V)	DC(V)	Vn(V _{DC})	Min.	Max.	Vc(V)	I _p (A)	(J)	(A)	(W)	(pF)	
FMOV10180-P	11	14	18	16	20	36	5	4	1500	0.08	8000	C _{RU} US
FMOV10220-P	14	18	22	20	24	43	5	5	1500	0.08	7000	
FMOV10270-P	17	22	27	24	30	53	5	6	1500	0.08	5500	
FMOV10330-P	20	26	33	30	36	65	5	7.5	1500	0.08	4100	
FMOV10390-P	25	31	39	35	43	77	5	8.6	1500	0.08	3900	
FMOV10470-P	30	38	47	42	52	93	5	10	1500	0.08	3300	
FMOV10560-P	35	45	56	50	62	110	5	11	1500	0.08	2800	
FMOV10680-P	40	56	68	61	75	135	5	14	1500	0.08	2300	
FMOV10201-P	130	170	200	180	220	340	25	52	4000	0.4	625	C _{RU} US VDE
FMOV10221-P	140	180	220	198	242	360	25	58	4000	0.4	570	
FMOV10241-P	150	200	240	216	264	395	25	64	4000	0.4	525	
FMOV10271-P	175	225	270	243	297	455	25	67	4000	0.4	470	
FMOV10301-P	195	250	300	270	330	500	25	70	4000	0.4	415	
FMOV10331-P	215	275	330	297	363	550	25	72	4000	0.4	350	
FMOV10361-P	230	300	360	324	396	595	25	76	4000	0.4	350	
FMOV10391-P	250	320	390	351	429	650	25	82	4000	0.4	325	
FMOV10431-P	275	350	430	387	473	710	25	93	4000	0.4	290	
FMOV10471-P	300	385	470	423	517	775	25	99	4000	0.4	260	
FMOV10511-P	320	410	510	459	561	845	25	107	4000	0.4	240	
FMOV10561-P	350	460	560	504	616	915	25	113	4000	0.4	220	
FMOV10621-P	395	510	620	558	682	1020	25	125	4000	0.4	200	
FMOV10681-P	420	560	680	612	748	1120	25	128	4000	0.4	190	
FMOV10751-P	465	615	750	675	825	1235	25	134	4000	0.4	175	
FMOV10781-P	485	640	780	702	858	1290	25	140	4000	0.4	170	
FMOV10821-P	510	670	820	738	902	1355	25	146	4000	0.4	160	
FMOV10911-P	550	745	910	819	1001	1500	25	152	4000	0.4	140	
FMOV10102-P	625	825	1000	900	1100	1650	25	170	4000	0.4	132	
FMOV10112-P	680	895	1100	990	1210	1815	25	180	4000	0.4	120	

FMOV14-P Series

Device Ratings and Characteristics												
Part Number	Maximum Continuous Voltage		Varistor Voltage (@1mA)			Maximum Clamping Voltage @Test Current (@8/20µs)		Maximum Energy (@10/1000µs)	Maximum Peak Current (@8/20µs)	Rated Power	Typical Capacitance (@1KHz)	Agency Approval
	ACrms(V)	DC(V)	Vn(Vbc)	Min.	Max.	Vc(V)	Ip(A)	(J)	(A)	(W)	(pF)	
FMOV14180-P	11	14	18	16	20	36	10	11	3000	0.15	18500	C  US
FMOV14220-P	14	18	22	20	24	43	10	14	3000	0.15	16400	
FMOV14270-P	17	22	27	24	30	53	10	18	3000	0.15	13000	
FMOV14330-P	20	26	33	30	36	65	10	23	3000	0.15	9500	
FMOV14390-P	25	31	39	35	43	77	10	26	3000	0.15	8800	
FMOV14470-P	30	38	47	42	52	93	10	33	3000	0.15	7700	
FMOV14560-P	35	45	56	50	62	110	10	41	3000	0.15	6400	
FMOV14680-P	40	56	68	61	75	135	10	46	3000	0.15	5600	
FMOV14201-P	130	170	200	180	220	340	50	96	8000	0.6	770	C  US 
FMOV14221-P	140	180	220	198	242	360	50	104	8000	0.6	740	
FMOV14241-P	150	200	240	216	264	395	50	112	8000	0.6	700	
FMOV14271-P	175	225	270	243	297	455	50	120	8000	0.6	640	
FMOV14301-P	195	250	300	270	330	500	50	136	8000	0.6	600	
FMOV14331-P	215	275	330	297	363	550	50	152	8000	0.6	580	
FMOV14361-P	230	300	360	324	396	595	50	164	8000	0.6	540	
FMOV14391-P	250	320	390	351	429	650	50	176	8000	0.6	500	
FMOV14431-P	275	350	430	387	473	710	50	200	8000	0.6	450	
FMOV14471-P	300	385	470	423	517	775	50	220	8000	0.6	400	
FMOV14511-P	320	410	510	459	561	845	50	240	8000	0.6	350	
FMOV14561-P	350	460	560	504	616	915	50	240	8000	0.6	350	
FMOV14621-P	395	510	620	558	682	1020	50	250	8000	0.6	330	
FMOV14681-P	420	560	680	612	748	1120	50	260	8000	0.6	320	
FMOV14751-P	465	615	750	675	825	1235	50	270	8000	0.6	300	
FMOV14781-P	485	640	780	702	858	1290	50	275	8000	0.6	300	
FMOV14821-P	510	670	820	738	902	1355	50	280	8000	0.6	270	
FMOV14911-P	550	745	910	819	1001	1500	50	295	8000	0.6	260	
FMOV14102-P	625	825	1000	900	1100	1650	50	335	8000	0.6	250	
FMOV14112-P	680	895	1100	990	1210	1815	50	360	8000	0.6	240	

FMOV20-P Series

Device Ratings and Characteristics												
Part Number	Maximum Continuous Voltage		Varistor Voltage (@1mA)			Maximum Clamping Voltage @Test Current (@8/20 μ s)		Maximum Energy (@10/1000 μ s)	Maximum Peak Current (@8/20 μ s)	Rated Power	Typical Capacitance (@1KHz)	Agency Approval
	ACrms(V)	DC(V)	Vn(V _{DC})	Min.	Max.	Vc(V)	I _p (A)	(J)	(A)	(W)	(pF)	
FMOV20180-P	11	14	18	16	20	36	20	20	6000	0.3	42000	C _{RU} US
FMOV20220-P	14	18	22	20	24	43	20	26	6000	0.3	37000	
FMOV20270-P	17	22	27	24	30	53	20	31	6000	0.3	29200	
FMOV20330-P	20	26	33	30	36	65	20	39	6000	0.3	21400	
FMOV20390-P	25	31	39	35	43	77	20	44	6000	0.3	19800	
FMOV20470-P	30	38	47	42	52	93	20	52	6000	0.3	17300	
FMOV20560-P	35	45	56	50	62	110	20	57	6000	0.3	14400	
FMOV20680-P	40	56	68	61	75	135	20	72	6000	0.3	12600	
FMOV20201-P	130	170	200	180	220	340	100	175	15000	1	1700	C _{RU} US VDE
FMOV20221-P	140	180	220	198	242	360	100	185	15000	1	1600	
FMOV20241-P	150	200	240	216	264	395	100	198	15000	1	1500	
FMOV20271-P	175	225	270	243	297	455	100	220	15000	1	1300	
FMOV20301-P	195	250	300	270	330	500	100	245	15000	1	1200	
FMOV20331-P	215	275	330	297	363	550	100	268	15000	1	1100	
FMOV20361-P	230	300	360	324	396	595	100	315	15000	1	1100	
FMOV20391-P	250	320	390	351	429	650	100	350	15000	1	1100	
FMOV20431-P	275	350	430	387	473	710	100	380	15000	1	1000	
FMOV20471-P	300	385	470	423	517	775	100	405	15000	1	900	
FMOV20511-P	320	410	510	459	561	845	100	445	15000	1	800	
FMOV20561-P	350	460	560	504	616	915	100	475	15000	1	750	
FMOV20621-P	395	510	620	558	682	1020	100	490	15000	1	570	
FMOV20681-P	420	560	680	612	748	1120	100	500	15000	1	550	
FMOV20751-P	465	615	750	675	825	1235	100	525	15000	1	530	
FMOV20781-P	485	640	780	702	858	1290	100	535	15000	1	500	
FMOV20821-P	510	670	820	738	902	1355	100	545	15000	1	500	
FMOV20911-P	550	745	910	819	1001	1500	100	595	15000	1	480	
FMOV20102-P	625	825	1000	900	1100	1650	100	650	15000	1	460	
FMOV20112-P	680	895	1100	990	1210	1815	100	720	15000	1	400	

Transient V-I Characteristic Curves

FMOV10201-P to FMOV10471-P

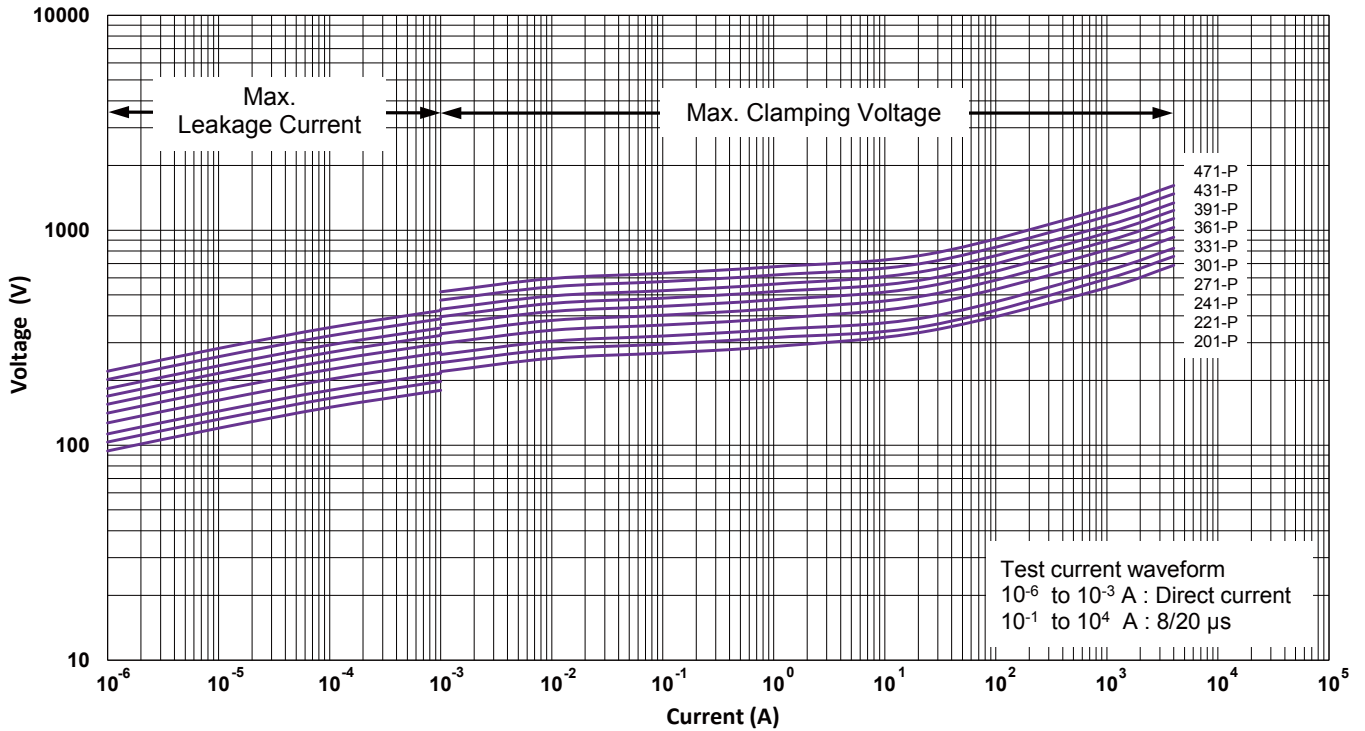

FMOV10511-P to FMOV10112-P

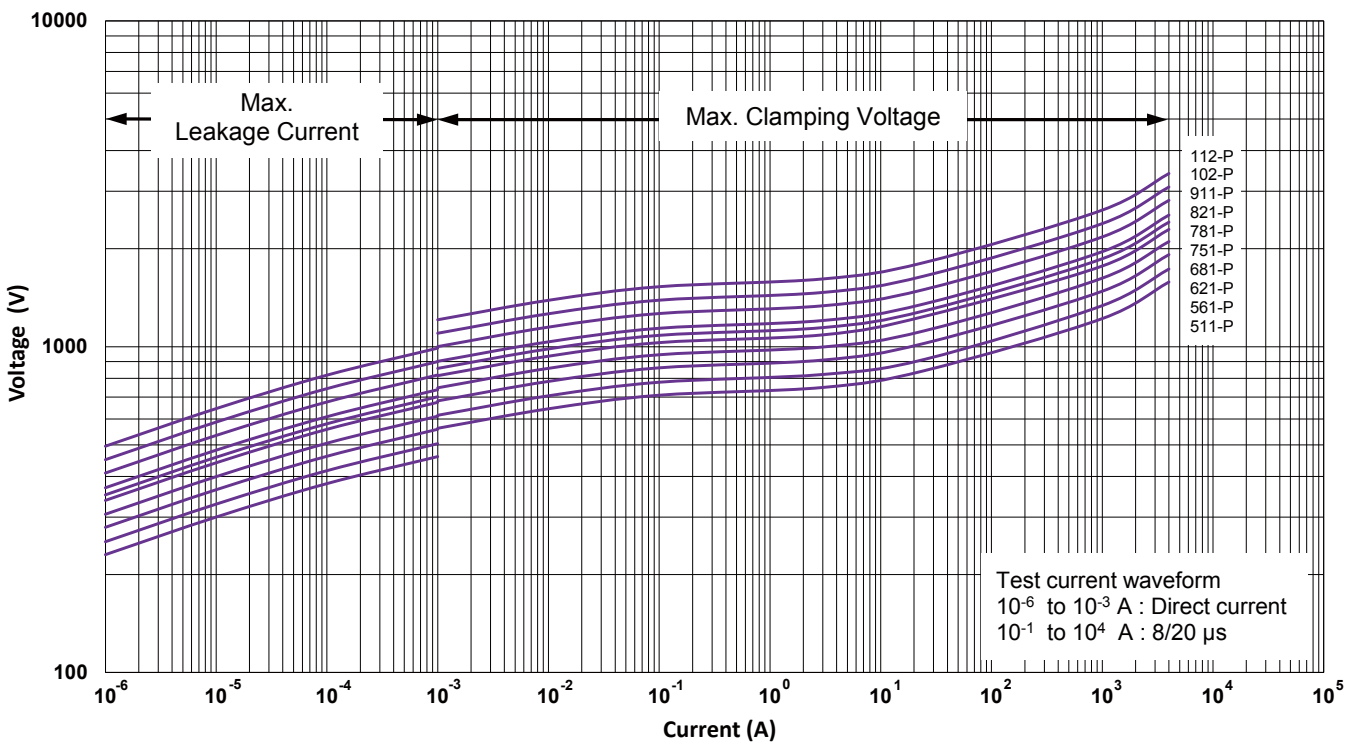

Transient V-I Characteristic Curves

FMOV14201-P to FMOV14471-P

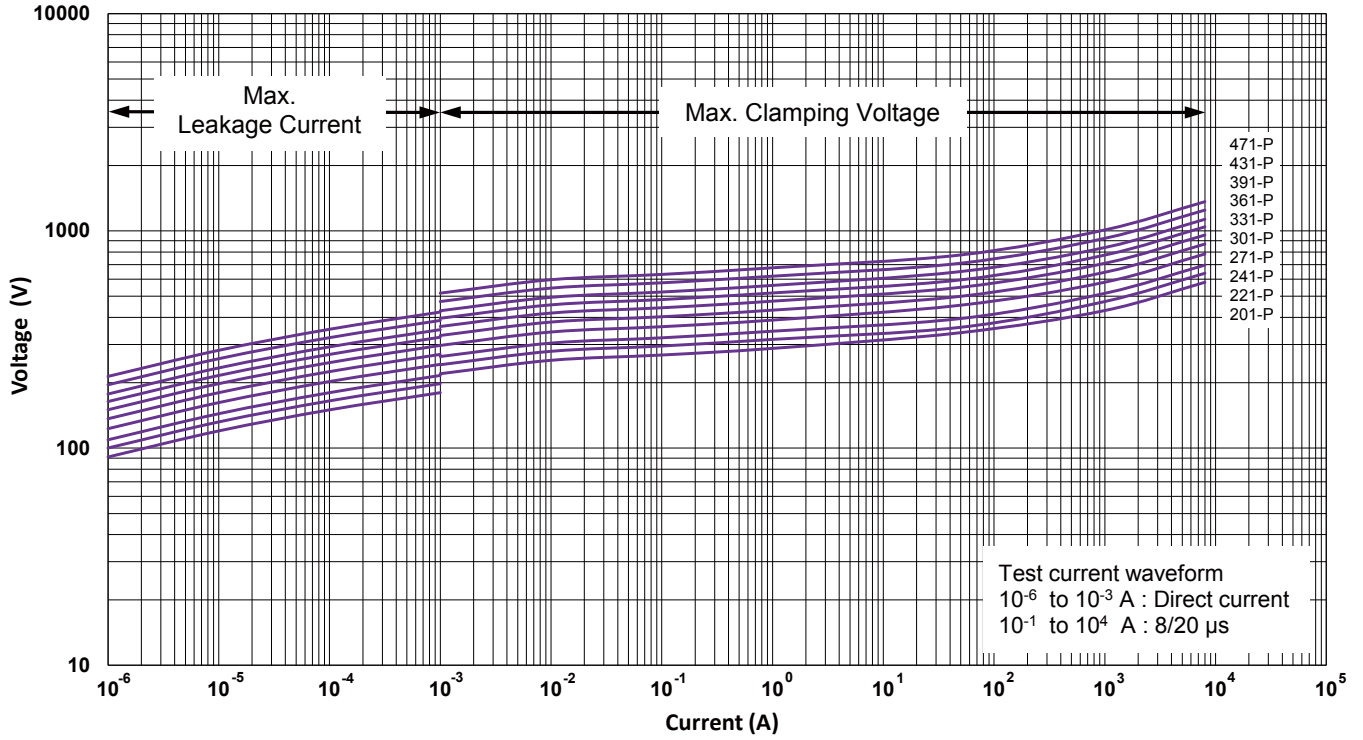

FMOV14511-P to FMOV14112-P

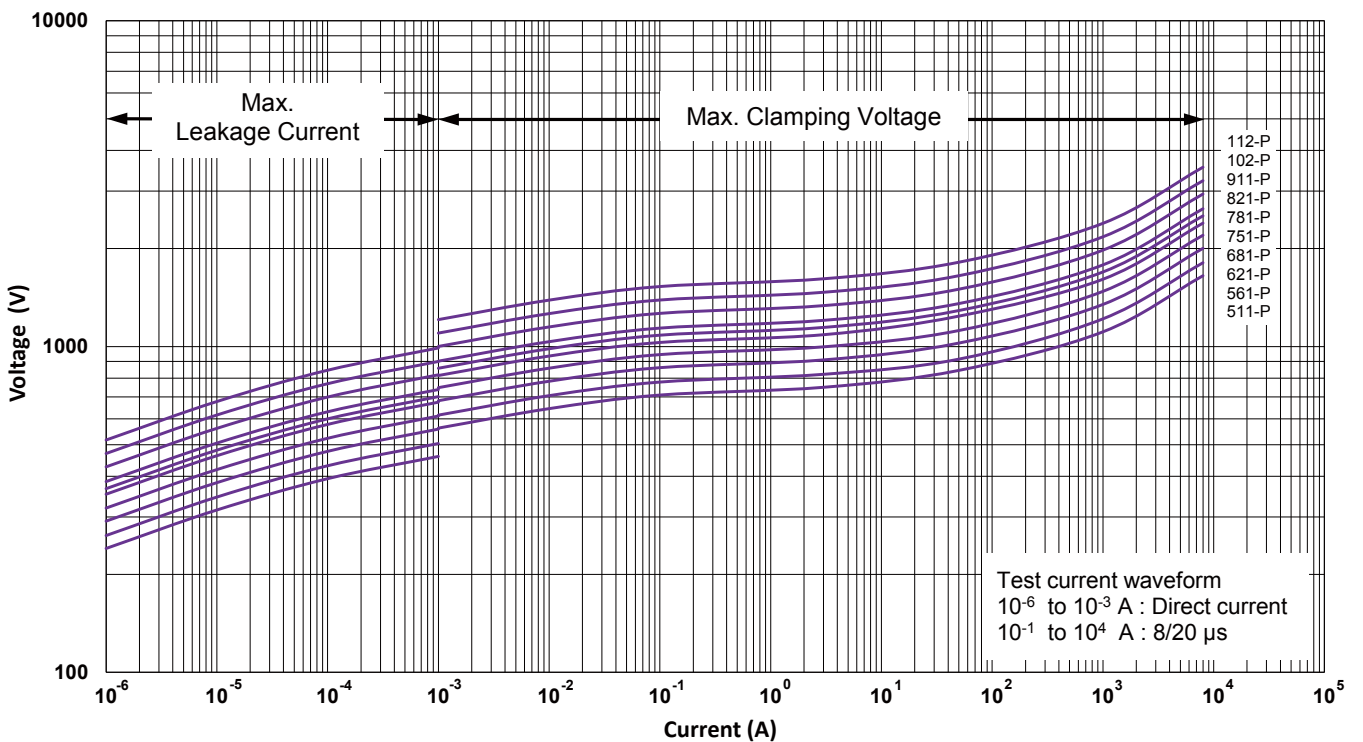

Transient V-I Characteristic Curves

FMOV20201-P to FMOV20471-P

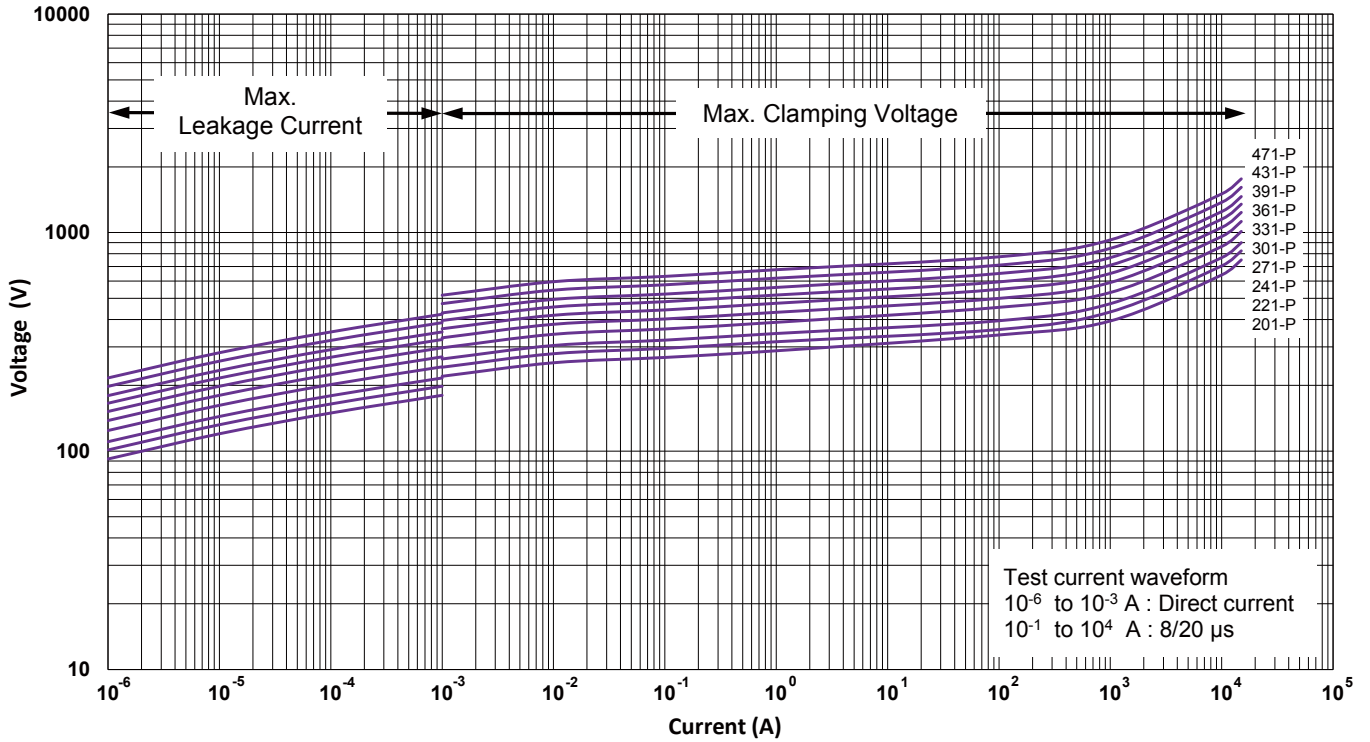

FMOV20511-P to FMOV20112-P

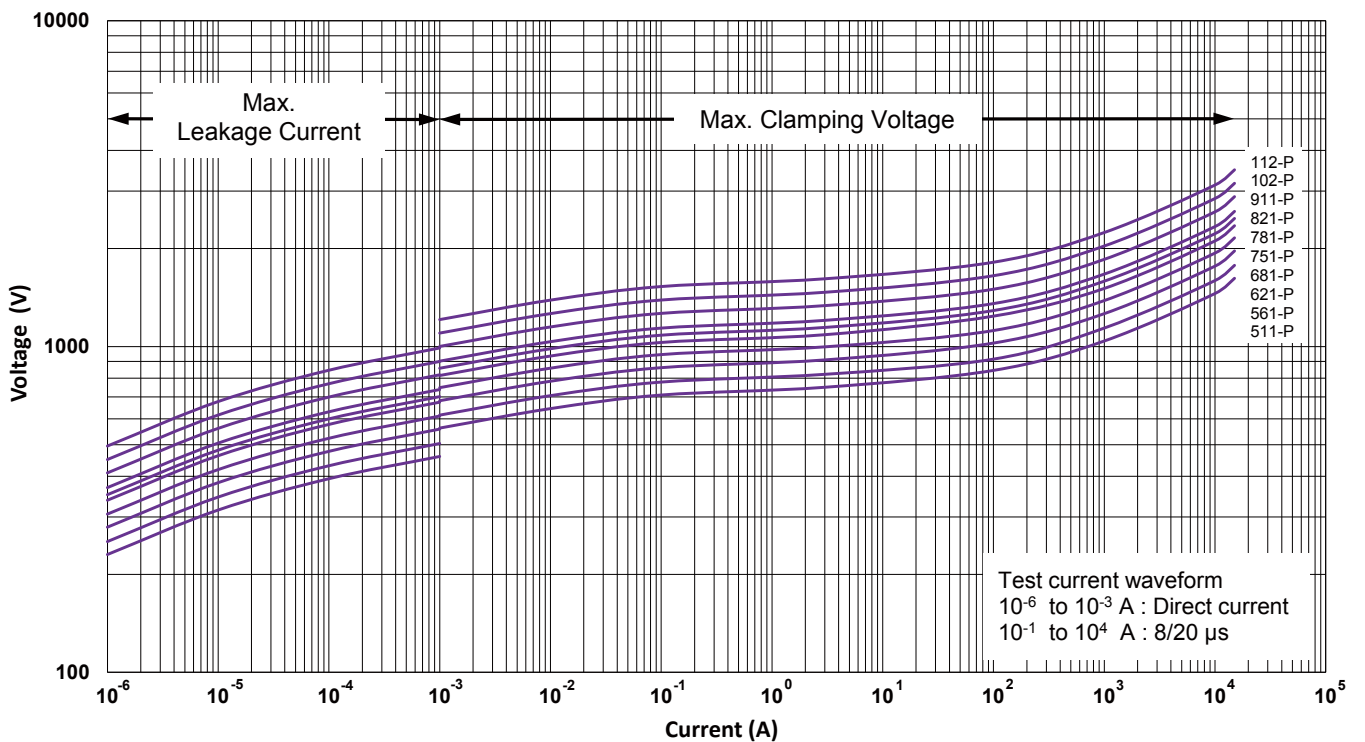

Impulse Life Time Rating Curves

FMOV10180-P to FMOV10680-P

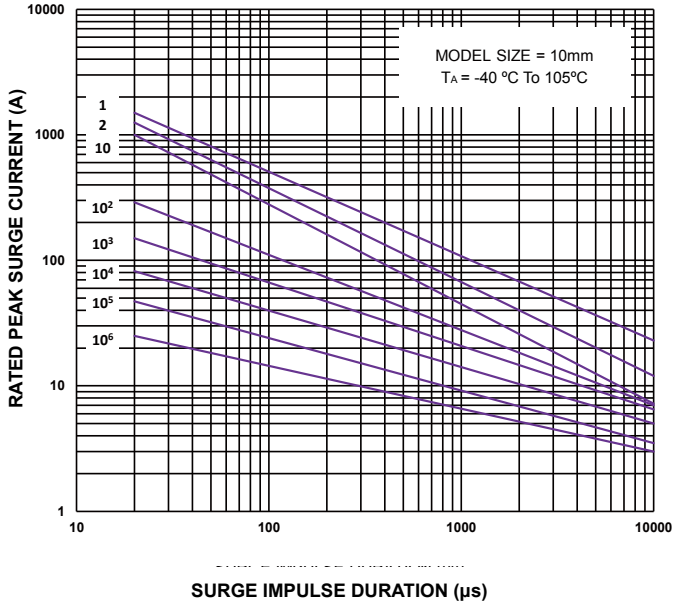

FMOV10201-P to FMOV10751-P

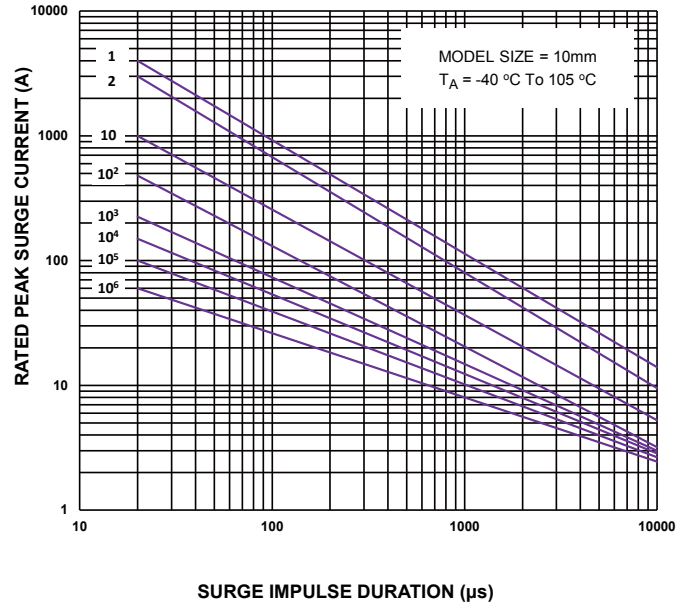

FMOV10781-P to FMOV10112-P

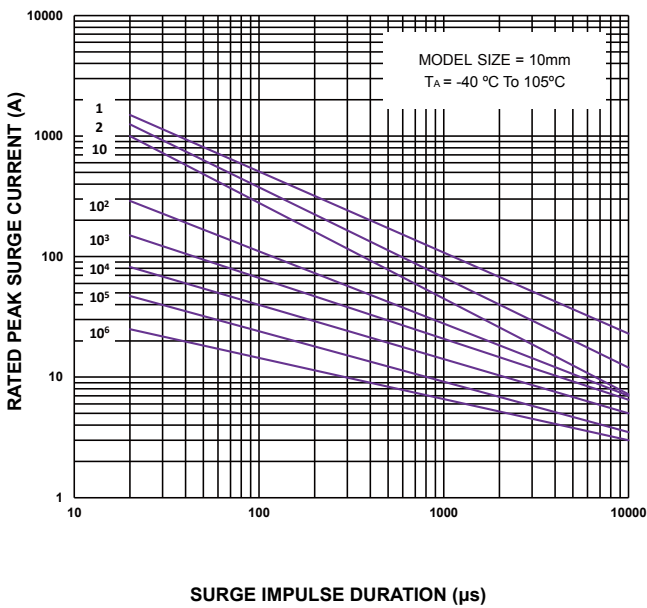

FMOV14180-P to FMOV14680-P

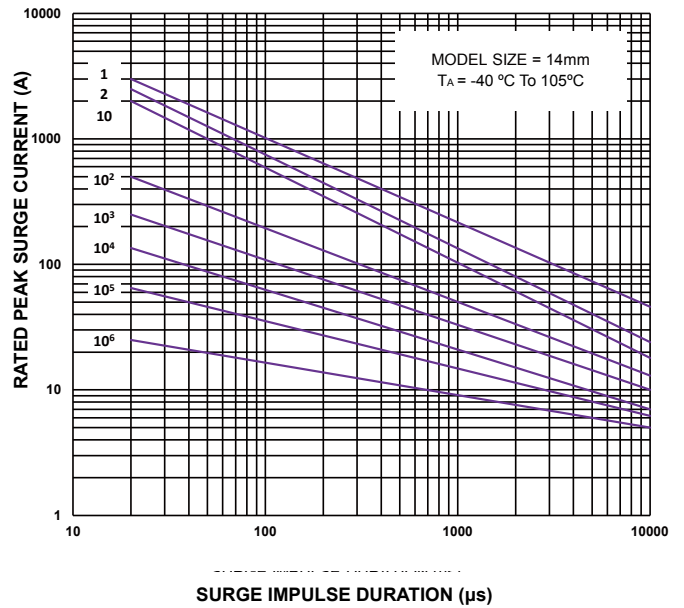

Impulse Life Time Rating Curves

FMOV14201-P to FMOV14751-P

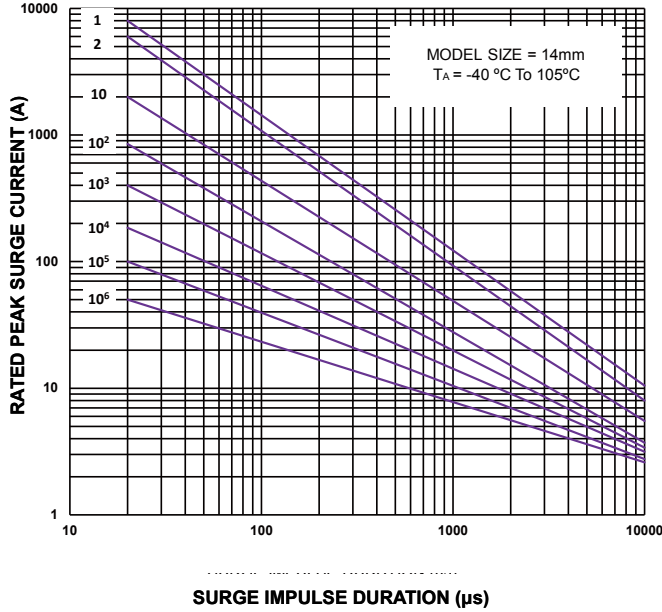

FMOV14781-P to FMOV14112-P

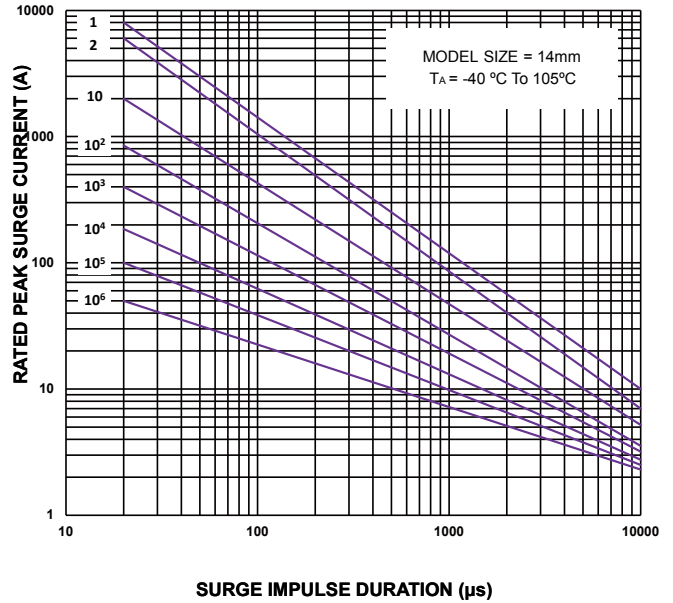

FMOV20180-P to FMOV20680-P

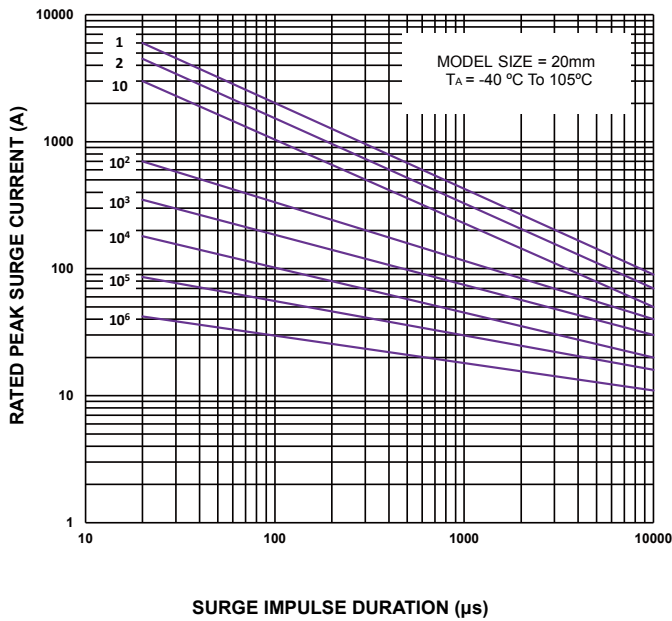

FMOV20201-P to FMOV20112-P

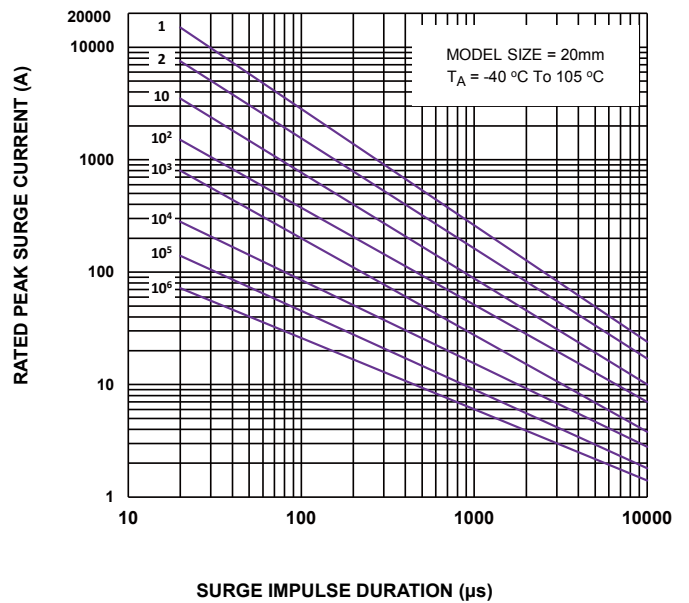

Power Derating Curve

Should transients occur in rapid succession, the average power dissipation is the energy (watt-seconds) per pulse times the number of pulses per second. The power so developed must be with the specifications shown on the Device Ratings and Specifications Table for the specific device. The operating values of a MOV need to be derated at high temperatures as shown above. Because varistors only dissipate a relatively small amount of average power they are not suitable for repetitive applications that involve substantial amounts of average power dissipation.

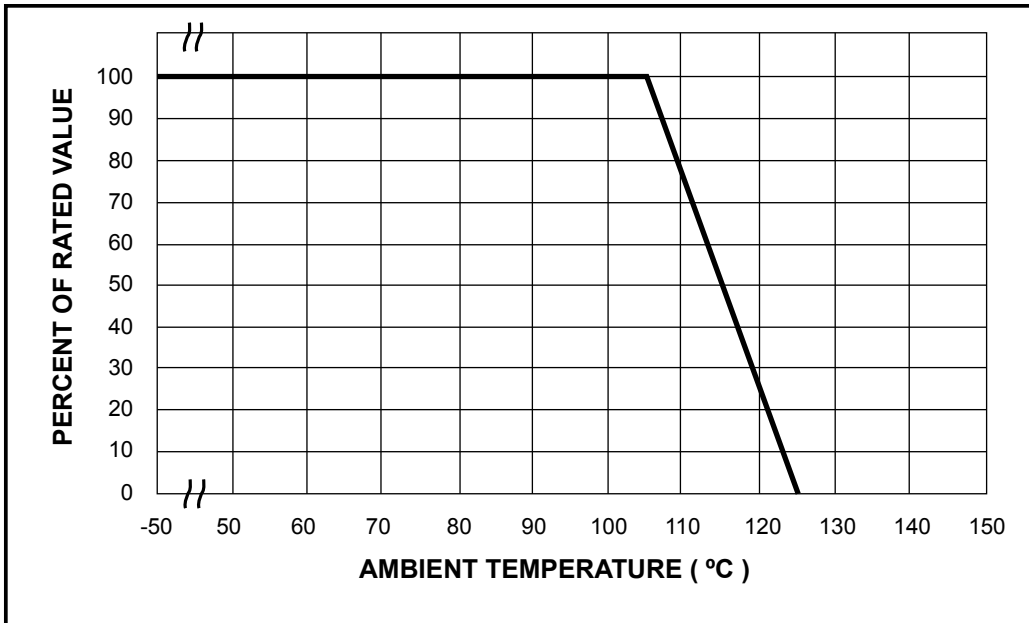

Surge Current Standard Waveform

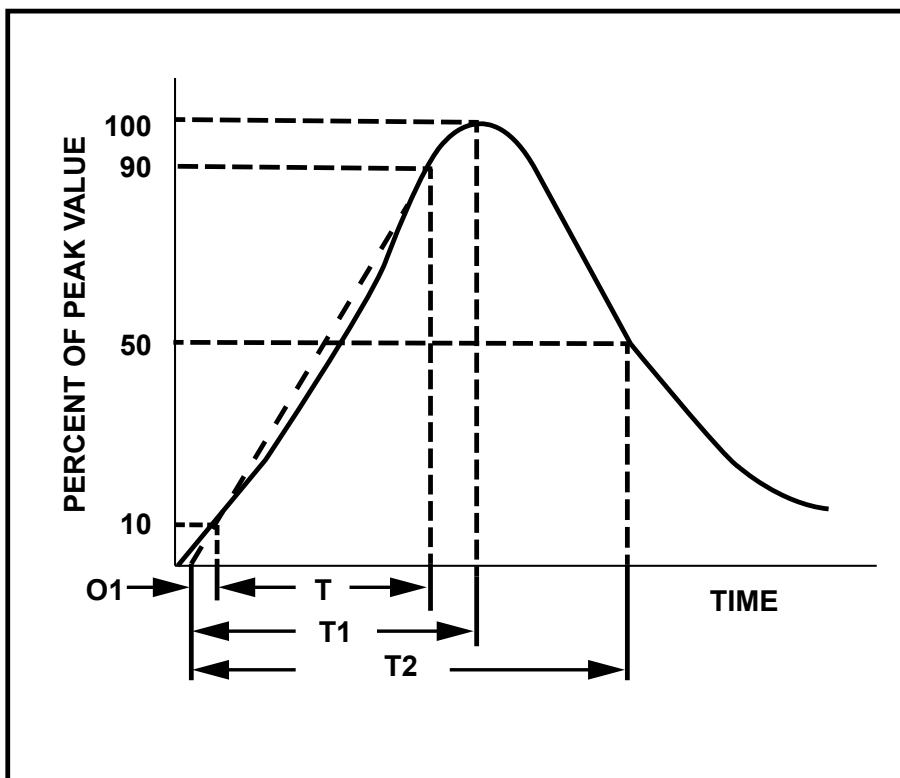

O1 = Virtual Origin of Wave
 T = Time from 10% to 90% of Peak
 $T1 = \text{Rise Time} = 1.25 \times T$
 $T2 = \text{Decay Time}$
 Example - For an 8/20 μs Current Waveform :
 $8\mu\text{s} = T1 = \text{Rise Time}$
 $20\mu\text{s} = T2 = \text{Decay Time}$

Product Dimensions

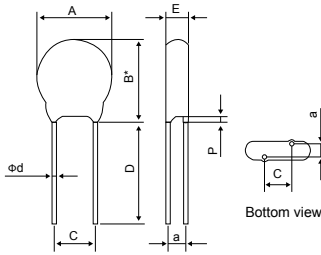

Fig 1. Straight Lead

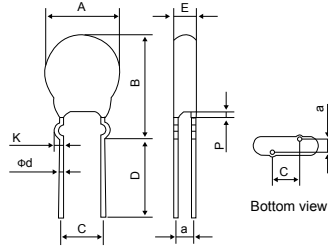

Fig 2. Outside Kink Lead

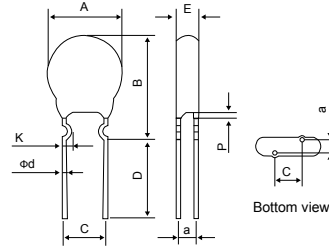

Fig 3. Inside Kink Lead

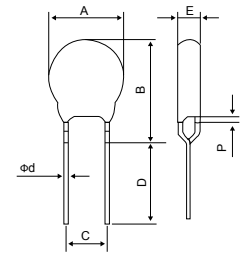

Fig 4. In Line Kink Lead

Dimension Table

Unit : mm

Model size		10P		14P		20P	
		Min.	Max.	Min.	Max.	Min.	Max.
A		10.5	14.0	13.5	17.5	19.2	25.0
B(Max.)	201-P ~ 271-P	-	19.5	-	22.5	-	30.0
	>271-P	-	20.5	-	23.5	-	31.0
B*(Max.)		-	17	-	20.5	-	28.0
C(±1.0)		7.5		7.5		10.0	
D(Typ.)		25.0		25.0		25.0	
P(Max.)		-	3.0	-	3.0	-	3.0
K		1.0	1.8	1.0	1.8	1.0	1.8
Φd(±0.05)		0.8		0.8		1.0	
E		E Max. Table					

E Max. Table

Unit : mm

Model	10p	14p	20p	a (±1.0)	Model	10p	14p	20p	a (±1.0)
180-P	3.9	4.0	4.2	1.5	361-P	5.4	5.5	6.0	2.1
220-P	4.2	4.3	4.6	1.7	391-P	5.5	5.6	6.1	2.3
270-P	4.4	4.5	4.8	1.8	431-P	5.7	5.8	6.4	2.4
330-P	3.9	4.0	4.3	1.9	471-P	5.9	6.0	6.6	2.5
390-P	4.1	4.2	4.5	1.9	511-P	6.1	6.2	6.7	2.6
470-P	4.3	4.4	4.7	2.1	561-P	6.3	6.4	6.9	2.8
560-P	4.6	4.7	5.0	2.3	621-P	6.5	6.6	7.2	3.1
680-P	4.9	5.0	5.3	2.6	681-P	6.6	6.7	7.3	3.3
201-P	4.5	4.6	5.1	1.5	751-P	6.8	6.9	7.5	3.6
221-P	4.6	4.7	5.2	1.6	781-P	7.2	7.3	7.9	3.8
241-P	4.7	4.8	5.3	1.7	821-P	7.4	7.5	8.1	4.0
271-P	4.8	4.9	5.4	1.8	911-P	7.5	7.6	8.2	4.3
301-P	4.9	5.0	5.5	1.9	102-P	8.0	8.1	8.7	4.6
331-P	5.1	5.2	5.8	2.0	112-P	8.9	9.0	9.3	5.2

Part Numbering and Marking System

Part Numbering System :

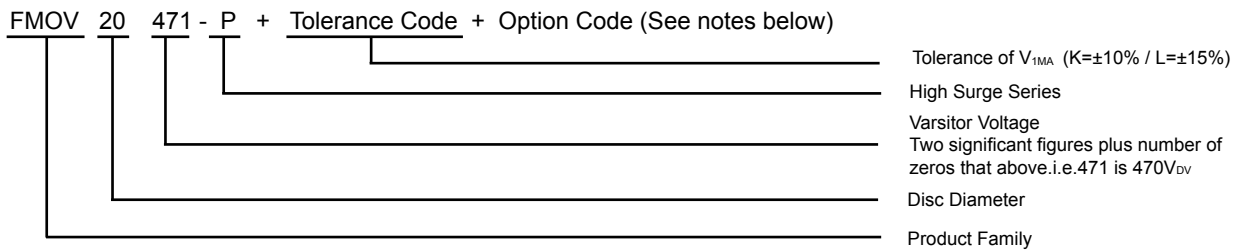

Marking System :

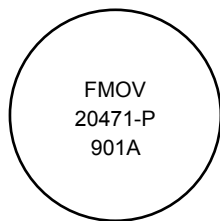

Example

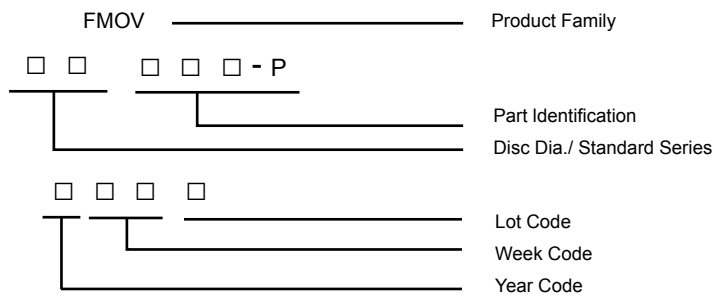

Order Notes

Main Part Code :

Part No + Tolerance Code + Packaging + Lead Type Designators + Option Code

Ordering examples :

Straight Lead Bulk Pack (Standard)	Straight Lead (Short Cut) Bulk Pack	Straight Lead Tape & Reel Pack	Straight Lead Flat Box Pack
FMOV10471-PKBS	FMOV10471-PKBSXXX	FMOV10471-PKTS	FMOV10471-PKAS
FMOV14471-PKBS	FMOV14471-PKBSXXX	FMOV14471-PKTS	FMOV14471-PKAS
FMOV20471-PKBS	FMOV20471-PKBSXXX	-	-

Tape & Reel Pack Feed Hole Pitch
FMOV10471-PKTSA
FMOV10471-PKTSB
FMOV14471-PKTSA
FMOV14471-PKTSB

Outside Kink Lead Bulk Pack	Outside Kink lead (Short Cut) Bulk Pack	Outside Kink Lead Tape & Reel Pack	Outside Kink Lead Flat Box Pack
FMOV10471-PKBO	FMOV10471-PKBOXXX	FMOV10471-PKTO	FMOV10471-PKAO
FMOV14471-PKBO	FMOV14471-PKBOXXX	FMOV14471-PKTO	FMOV14471-PKAO
FMOV20471-PKBO	FMOV20471-PKBOXXX	-	-

A : P0 → 12.7mm±0.2mm
B : P0 → 15.0mm±0.2mm

Inside Kink lead Bulk Pack	Inside Kink Lead (Short Cut) Bulk Pack	Inside Kink Lead Tape & Reel Pack	Inside Kink Lead Flat Box Pack
FMOV10471-PKBK	FMOV10471-PKBKXXX	FMOV10471-PKTK	FMOV10471-PKAK
FMOV14471-PKBK	FMOV14471-PKBKXXX	FMOV14471-PKTK	FMOV14471-PKAK
FMOV20471-PKBK	FMOV20471-PKBKXXX	-	-

In Line Kink Lead Bulk Pack	In Line Kink Lead (Short Cut) Bulk Pack	In Line Kink Lead Tape & Reel Pack	In Line Kink Lead Flat Box Pack
FMOV10471-PKBI	FMOV10471-PKBIXXX	FMOV10471-PKTI	FMOV10471-PKAI
FMOV14471-PKBI	FMOV14471-PKBIXXX	FMOV14471-PKTI	FMOV14471-PKAI
FMOV20471-PKBI	FMOV20471-PKBIXXX	-	-

Tape and Reel Specifications

Radial devices on tape are supplied with straight leads or inline kink leads

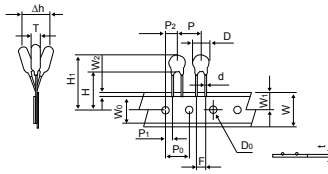

Figure: A

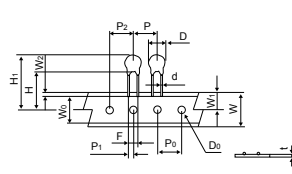

Figure: B

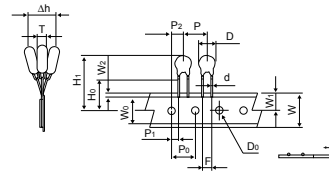

Figure: C

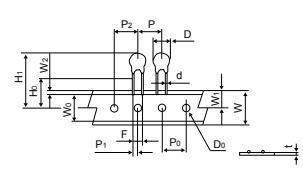

Figure: D

Straight Leads

Inline Kink Leads

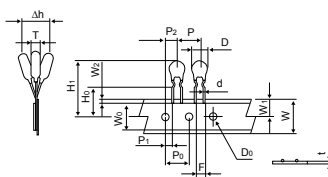

Figure: E

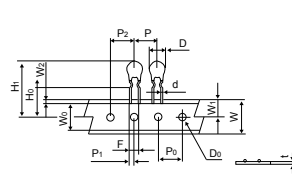

Figure: F

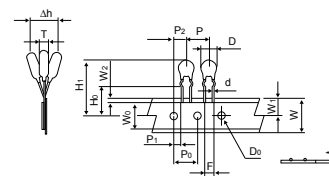

Figure: G

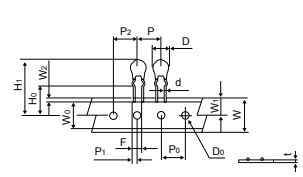

Figure: H

Inside Kink Leads

Outside Kink Leads

Symbol	Parameter	Model			
		10P		14P	
P	Pitch of Component	12.7±1.0	15.0±1.0	25.4±1.0	30.0±1.0
P0	Feed Hole Pitch	12.7±0.2	15.0±0.2	12.7±0.2	15.0±0.2
P1	Feed Hole Center Lead	3.85±0.7	3.75±0.7	8.95±0.7	3.75±0.7
P2	Hole center to Component Center	6.35±0.7	7.5±0.7	12.7±0.7	7.5±0.7
F	Lead to Lead Distance	7.5±0.8	7.5±0.8	7.5±0.8	7.5±0.8
Δh	Component Alignment	2.0 Max	2.0 Max	2.0 Max	2.0 Max
W	Tape Width	18.0+1.0	18.0+1.0	18.0+1.0	18.0+1.0
		18.0-0.5	18.0-0.5	18.0-0.5	18.0-0.5
W0	Hold Down Tape Width	5.0 Min	5.0 Min	5.0 Min	5.0 Min
W1	Hole Position	9.0+0.75	9.0+0.75	9.0+0.75	9.0+0.75
		9.0-0.50	9.0-0.50	9.0-0.50	9.0-0.50
W2	Hold Down Tape Position	3.0 Max	3.0 Max	3.0 Max	3.0 Max
H	Height from Tape Center to Component Base	18.0+2.0	18.0+2.0	18.0+2.0	18.0+2.0
		18.0-0.0	18.0-0.0	18.0-0.0	18.0-0.0
H0	Seating Plane Height	16.0±0.5	16.0±0.5	16.0±0.5	16.0±0.5
H1	Component Height	36.0 Max	36.0 Max	40.0 Max	40.0 Max
D0	Feed Hole Diameter	4.0±0.2	4.0±0.2	4.0±0.2	4.0±0.2
t	Total Tape Thickness	0.7±0.2	0.7±0.2	0.7±0.2	0.7±0.2
L	Length of Clipped Lead	11.0 Max	11.0 Max	11.0 Max	11.0 Max
Figure		ACEG	BDFH	ACEG	BDFH

Unit: mm

Packaging Specifications

Bulk Product Packing

Series	Straight Lead Type Quantity (pcs/bag)	Outside Kink Lead Type Quantity (pcs/bag)	Inside Kink Lead Type Quantity (pcs/bag)	In Line Kink Lead Type Quantity (pcs/bag)
FMOV10-P Series	500	500	500	500
FMOV14-P Series	500	500	500	500
FMOV20-P Series	250	250	250	250

Tape & Reel Product Packing

Series	A (mm)	Quantity (pcs/reel)
FMOV10(180~391)-P-T-	43	800
FMOV10(431~621)-P-T-		700
FMOV10(681~112)-P-T-		600
FMOV14(180~391)-P-T-	56	800
FMOV14(431~621)-P-T-		700
FMOV14(681~112)-P-T-		600

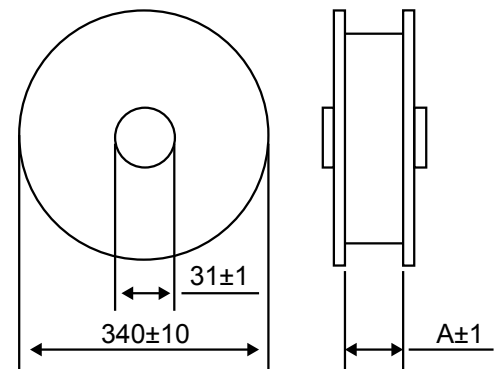

Box Product Packing

Series	Quantity (pcs/reel)
FMOV10(180~391)-P-A-	500
FMOV10(431~621)-P-A-	500
FMOV10(681~112)-P-A-	400
FMOV14(180~391)-P-A-	500
FMOV14(431~621)-P-A-	500
FMOV14(681~112)-P-A-	400

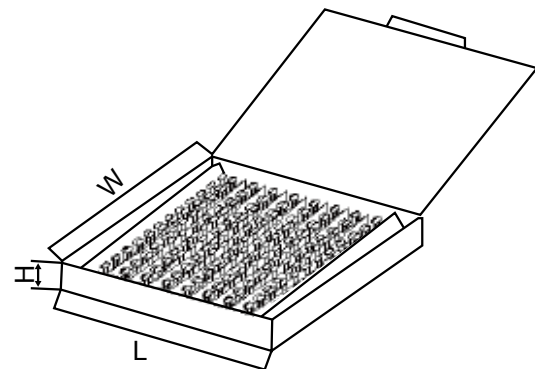

Series	L ± 5	W ± 5	H ± 5
FMOV10-P Series	340	245	45
FMOV14-P Series	340	245	50

Characteristics	Standard	Test Conditions	Specifications
Robustness of terminations	IEC 60068-2-21 Test Ua1	F = 10 N (d ≤ 0.8 mm) , F = 20 N (d = 1 mm)	$\Delta V_{1mA} / V_{1mA} \leq \pm 10\%$ No visible damage
Solderability	IEC 60068-2-20 Test Ta (Method 1)	T = 235±5°C, d = 2±0.5s	Approximately ≥95%
Resistance to soldering heat	IEC 60068-2-20 Test Tb (Method 1A)	T = 260±5°C, d = 10±1s	$\Delta V_{1mA} / V_{1mA} \leq \pm 5\%$ No visible damage
Shock	IEC 60068-2-27 Test Ea	Pulse shape: half-sine. a = 490 m/s ² , d = 11ms. N = 6 x 3 shocks	$\Delta V_{1mA} / V_{1mA} \leq \pm 5\%$ No visible damage
Vibration	IEC 60068-2-6 Test Fc Method B4	Frequency range : 10 Hz to 55 Hz , a = 0.75 mm or 98 m/s ² (whichever is the less), d = 3x2 h	$\Delta V_{1mA} / V_{1mA} \leq \pm 5\%$ No visible damage
Needle flame test	IEC 60695-11-5	Severity : Vertical 10 s	Duration of burning: 5 s max.
Voltage under pulse condition	IEC 61051-2	At class current, 8/20 μs,	As specified in specification
Voltage proof	IEC 61051-2	Metal balls method (4.8.1.2) 2500 V, 60 s	No breakdown or flashover
Pulse current - 8/20 μs	IEC 61051-2	8/20 μs, 10 times, I _{peak} = 0.25*I _{max}	$\Delta V / V \leq \pm 10\%$ No visible damage
Pulse current - 10/1000 μs	IEC 61051-2	10/1000 μs, 10 times, I _{peak} = 0.0075* I _{max}	$\Delta V_{1mA} / V_{1mA} \leq \pm 10\%$ No visible damage
Combination pulse	IEC 60950-1:2013 Annex Q	Additional test : 10 pulses (combination pulse 6KV/3KA), in one direction, 1 per min	$\Delta V_{1mA} / V_{1mA} \leq \pm 10\%$ No visible damage U ≤ 1.1 U _{initial} Voltage proof : No breakdown or flashover
Rapid change of temperature	IEC 60068-2-14 Test Na	N = 5 cycles, d = 30 min , θA = -40±3°C, θB = 85±2°C	$\Delta V_{1mA} / V_{1mA} \leq \pm 10\%$ No visible damage
Climatic sequence	IEC 60068-2-2 Test Ba IEC 60068-2-30 Test Db IEC 60068-2-1 Test Aa IEC 60068-2-30 Test Db	Dry heat, Test Ba:16±2h, T = 85±2°C Damp heat, Test Db first cycle : 24h, T = 55±2°C Cold, Test Aa : 2h, T = -40±3°C Damp heat Test Ba remaining cycles:5 cycle	$\Delta V_{1mA} / V_{1mA} \leq \pm 10\%$ No visible damage RISO ≥ 100MΩ Voltage proof : No breakdown or flashover
Endurance at upper category temperature	IEC 61051-1 (4.21)	T : max temperature as specified , Duration : 1000 h, Voltage : max. a. c. voltage	$\Delta V / V \leq \pm 10\%$ No visible damage RISO ≥ 1000MΩ U ≤ 1,1 U _{initial}
Damp heat (Steady state)	IEC 60068-2-78 Test Ca	T = 40±2°C, RH = 93(+2/-3)%, 56d , 4 specimens : No voltage applied ,Other 4 specimens : Applied voltage : 10% of the max. d. c. voltage	$\Delta V_{1mA} / V_{1mA} \leq \pm 10\%$ RISO ≥ 100MΩ
Maximum Peak Current	Specification Standard	I _{max} , 8/20 μs, 1 time.	$\Delta V_{1mA} / V_{1mA} \leq \pm 10\%$ No visible damage
Nominal Discharge Current Test	UL1449 4th	I _n , 8/20 μs, 15 times, Interval 60s	$\Delta V / V \leq \pm 10\%$ No visible damage
Varistor Voltage Temp. Coefficient	Specification Standard	$\frac{V_{1mA} \text{ at } 85^\circ\text{C} - V_{1mA} \text{ at } 25^\circ\text{C}}{V_{1mA} \text{ at } 25^\circ\text{C}} \times \frac{1}{60} \times 100(\% / ^\circ\text{C})$	0.05 ≤ TC ≤ 0.05(%/°C)
High Temperature Storage	IEC60068-2-2	1000h, T = 125±2°C	$\Delta V / V \leq \pm 5\%$ No visible damage
Max. Energy	Specification Standard	10/1000 μs, 1 times, Max. Energy	$\Delta V / V \leq \pm 10\%$ No visible damage
Operating duty cycle test *	UL1449	6 kV/3 kA combination wave surges, phase angle of 90 (+0, -15) degrees, positive polarity 8times, negative polarity 7 times, interval of 60s.	$\Delta V / V \leq \pm 10\%$ No visible damage
Surge Immunity Test *	IEC 61000-4-5	4kV/2kA combination wave surges, phase angle of 90 (+0, -15) degrees, positive polarity 20times, negative polarity 20times, interval of 60s.	$\Delta V / V \leq \pm 10\%$ No visible damage

Varistor Characteristic		Symbol
Varistor Voltage		
The voltage between two terminals with the specified measuring current C_m A DC applied is called V_c or V_c mA. The measurement shall be made as fast as possible to avoid affection		V_N
Maximum Allowable Voltage		
The maximum sinusoidal RMS voltage or maximum DC voltage that can be applied continuously in the specified environmental temperature range		V
Clamping Voltage		
The maximum voltage between two terminals with the specified standard *impulse current (8/20 μ S) is applied *Illustrated a below		V_c
Rated Power		
The power that can be applied in the specified ambient temperature		W
Maximum Energy		
The maximum energy within the varistor change of $\pm 10\%$ when one impulse of 2 ms or 10/100 μ S is applied.		J
Maximum Peak Current (Withstanding Surge Current)		
2 times : The maximum current within the varistor change of $\pm 10\%$ with the standard impulse current (8/20 μ S) applied two times with an interval of 5 minutes.		A
1 times : The maximum current within the varistor change of $\pm 10\%$ with the standard impulse current (8/20 μ S) applied one time.		
Temperature Coefficient of Varistor Voltage		
$\frac{V_c @ 85^\circ\text{C} - V_c @ 25^\circ\text{C}}{V_c @ 25^\circ\text{C}} \times \frac{1}{60} \times 100(\%^\circ\text{C})$		-0.05%/ $^\circ\text{C}$ max
Capacitance		
Capacitance shall be measured at 1 KHz $\pm 10\%$, 1 V _{rms} max, 0V bias and 20 $\pm 2^\circ\text{C}$.		C(pF)
Dissipation		
Dissipation Factor is measured at 1 KHz $\pm 10\%$, 1 V _{rms} max. 0V bias and 20 $\pm 2^\circ\text{C}$		
Withstanding Voltage (Body Insulation)		
The specified voltage shall be applied both terminals of the specimen connected together and metal foil closely wrapped round its body for 1 minute. Electrical breakdown shall be examined.		
Classification (Nominal Varistor Voltage)	Test Voltage (AC)	
$V_{0.1 \text{ mA}}, V_{1 \text{ mA}} \leq 330\text{V}$	1000 V _{rms}	
$V_{0.1 \text{ mA}}, V_{1 \text{ mA}} > 330\text{V}$	1500 V _{rms}	

* (According to customer requirements to meet the test items)

Lead Material (Tin Plated Copper Clad Steel or Tin Plated Copper)

Product Dimension	Voltage Range	Lead Diameter (± 0.05 mm)	Pitch (mm)
05 D/V	180~751	0.60 (CP)	5.0 ± 1.0
07 D/V	180~821	0.60 (CP)	5.0 ± 1.0
10 D/V	180~112	0.75 (CP)	7.5 ± 1.0
14 D/V	180~112	0.75 (CP)	7.5 ± 1.0
20 D/V/P	180~112	1.00 (CU)	10.0 ± 1.0
07 P	180~821	0.60 (CU)	5.0 ± 1.0
10 P	180~112	0.80 (CU)	7.5 ± 1.0
14 P	180~112	0.80 (CU)	7.5 ± 1.0

*CP: Tin Plated Copper Clad Steel; CU: Tin Plated Copper

Insulating Coating

Flame retardant epoxy, meets UL-94V-0 requirement

RoHS Compliant Declaration

We hereby declare that the components delivered to your company are compliant with RoHS Directive 2002/95/EC

Storage Conditions of Products

(I) Storage Conditions :

- a. Storage Temperature : $-10^{\circ}\text{C} \sim +40^{\circ}\text{C}$
- b. Relative Humidity : $\pm 75\% \text{RH}$
- c. Keep away from corrosive atmosphere and sunlight
- d. Solvent Resistance : MIL-STD-202, Method 215F
- e. Moisture Sensitivity : Level 1, J-STD-020

(II) Period of Storage : 1 year

Solder Recommendation

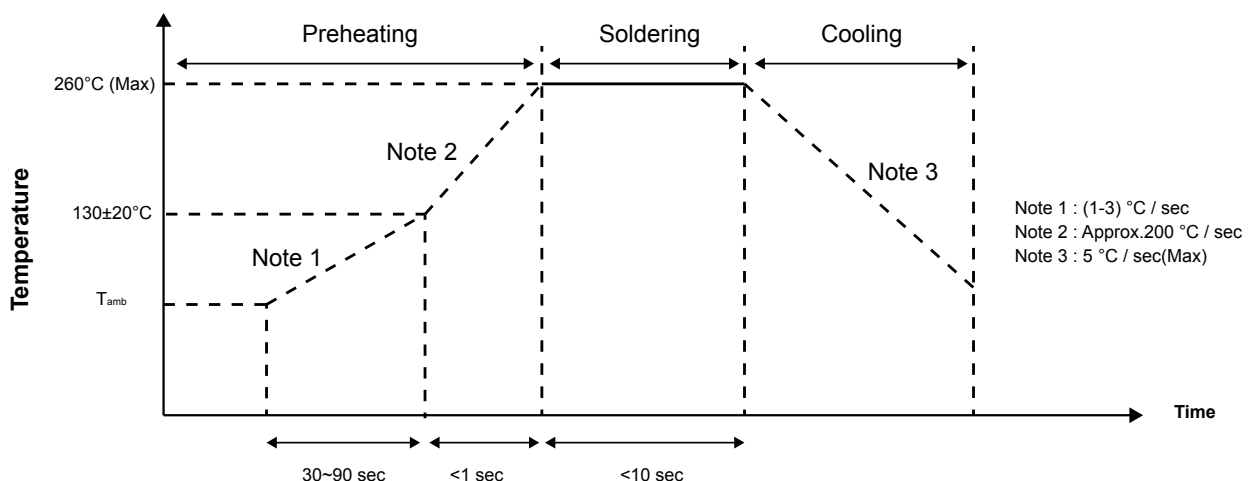

Recommendation Reworking Conditions with Soldering Iron

Item	Conditions
Temperature of soldering Iron-tip	$360^{\circ}\text{C (Max)}$
Soldering Time	3 sec (Max)
Distance from Varistor	2mm (Min)

Cross Reference					
	Fuzetec	Littelfuse	TDK&EPCOS	Thinking	BrightKing
Standard Series	D-Series	ZA/ LA	StandarD	TVR	VDR/ZOV/DB
	FMOV05201-D	-	SIOV-S5K130	TVR05201	201KD05
	FMOV07201-D	V130LA1P	SIOV-S7K130	TVR07201	201KD07
	FMOV10201-D	V130LA5P	SIOV-S10K130	TVR10201	201KD10
	FMOV14201-D	V130LA10AP	SIOV-S14K130	TVR14201	201KD14
	FMOV20201-D	V130LA20AP	SIOV-S20K130	TVR20201	201KD20
Medium Surge Series	V-Series	Ultra MOV	AdvanceD	TVR-V	High Energy
	FMOV05201-V	-	-	-	201KD05J
	FMOV07201-V	V07E130P	-	-	201KD07J
	FMOV10201-V	V10E130P	SIOV-S10K130E2	TVR10201-V	201KD10J
	FMOV14201-V	V14E130P	SIOV-S14K130E2	TVR14201-V	201KD14J
	FMOV20201-V	V20E130P	SIOV-S20K130E2	-	201KD20J
High Surge Series	P-Series	C III	AdvanceD-MP/ SuperioR	TVR-D	-
	FMOV10201-P	V130LA5CP	SIOV-S10K130E2K1	TVR07201KSW	-
	FMOV14201-P	V130LA10CP	SIOV-S14K130E2K1	TVR10201KSW	-
	FMOV20201-P	V130LA20CP	SIOV-S20K130E3K1	TVR20201KSW	-

MEMO

A series of horizontal dotted lines spanning the width of the page, providing a template for writing a memo.

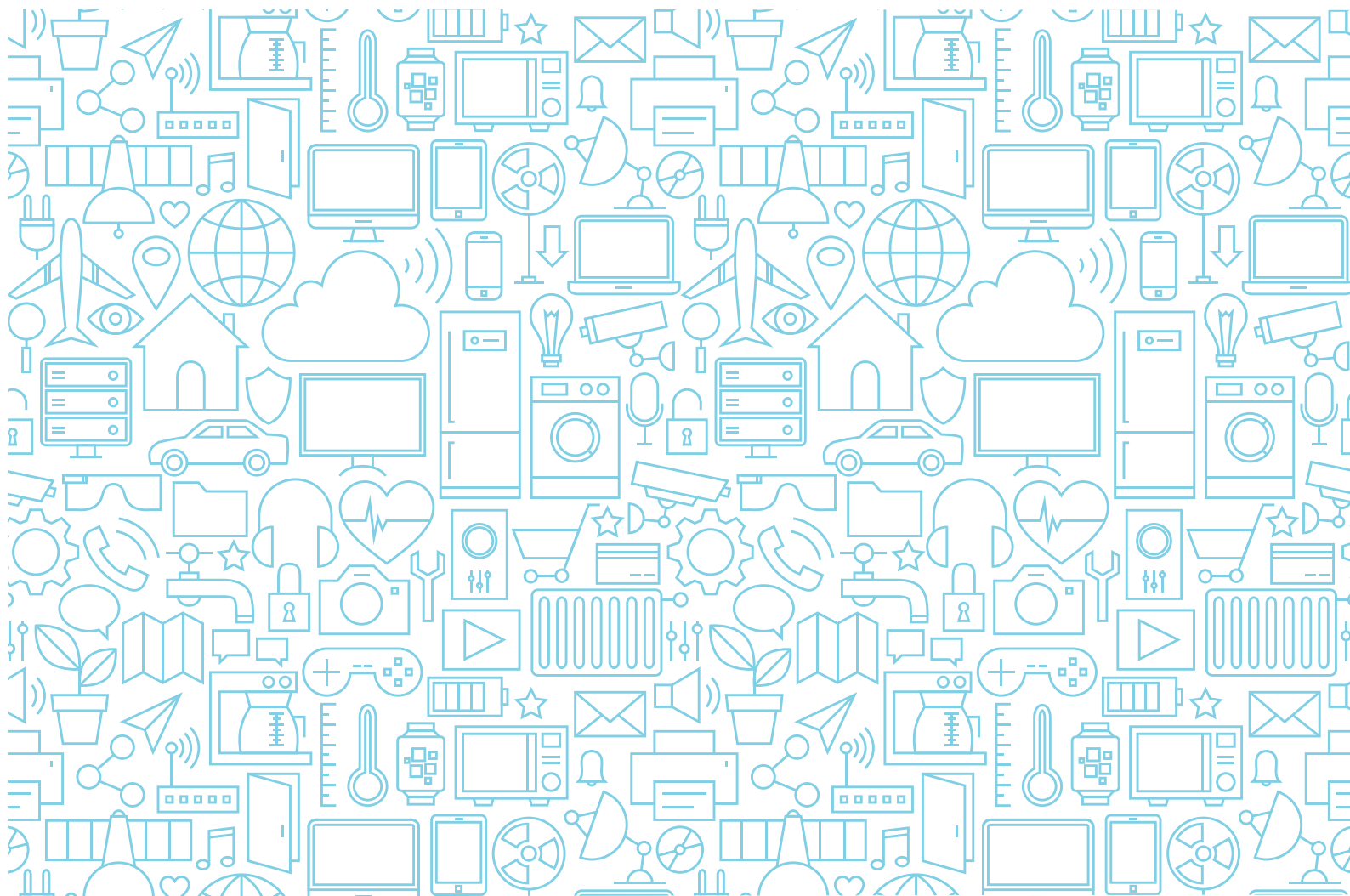

FUZETEC

FUZETEC TECHNOLOGY CO., LTD.

No.60, Wu-Gong 5 Road, Wu Gu Dist.,

New Taipei City, Taiwan 248020

TEL: 886 2 8990 2113 FAX: 886 2 8990 2110

E-mail: mail@fuzetec.com.tw

Website: www.fuzetec.com

富致科技股份有限公司

248020 新北市五股區五工五路60號

Agent